

GENERAL DESCRIPTION

The 85104I is a low skew, high performance 1-to-4 Differential/LVCMOS-to-0.7V HCSL Fanout Buffer. The 85104I has two selectable clock inputs. The CLK0, nCLK0 pair can accept most standard differential input levels. The single-ended CLK1 can accept LVCMOS or LVTTTL input levels. The clock enable is internally synchronized to eliminate runt clock pulses on the outputs during asynchronous assertion/deassertion of the clock enable pin.

Guaranteed output and part-to-part skew characteristics make the 85104I ideal for those applications demanding well defined performance and repeatability.

FEATURES

- Four 0.7V differential HCSL outputs
- Selectable differential CLK0, nCLK0 or LVCMOS inputs
- CLK0, nCLK0 pair can accept the following differential input levels: LVPECL, LVDS, LVHSTL, HCSL
- CLK1 can accept the following input levels: LVCMOS or LVTTTL
- Maximum output frequency: 500MHz
- Translates any single-ended input signal to 3.3V HCSL levels with resistor bias on nCLK input
- Output skew: 100ps (maximum)
- Part-to-part skew: 600ps (maximum)
- Propagation delay: 3.2ns (maximum)
- Additive phase jitter, RMS: 0.22ps (typical)
- 3.3V operating supply
- -40°C to 85°C ambient operating temperature
- Available in lead-free (RoHS 6) package

BLOCK DIAGRAM

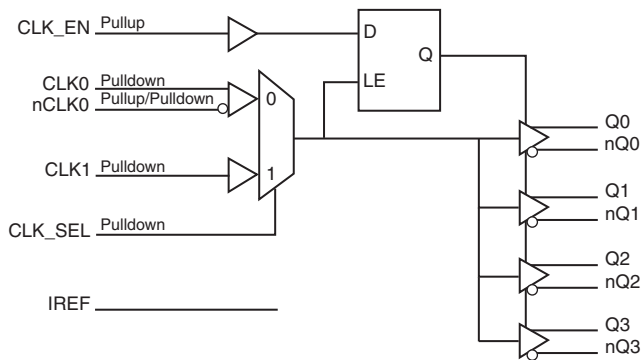

PIN ASSIGNMENT

GND	1	20	Q0
CLK_EN	2	19	nQ0
CLK_SEL	3	18	V _{DD}
CLK0	4	17	Q1
nCLK0	5	16	nQ1
CLK1	6	15	Q2
nc	7	14	nQ2
nc	8	13	V _{DD}
IREF	9	12	Q3
V _{DD}	10	11	nQ3

85104I
20-Lead TSSOP
 6.5mm x 4.4mm x 0.925mm Package Body
G Package
 Top View

TABLE 1. PIN DESCRIPTIONS

Number	Name	Type		Description
1	GND	Power		Power supply ground.
2	CLK_EN	Input	Pullup	Synchronizing clock enable. When HIGH, clock outputs follow clock input. When LOW, Qx outputs are forced low, nQx outputs are forced high. LVTTTL / LVCMOS interface levels.
3	CLK_SEL	Input	Pulldown	Clock select input. When HIGH, selects CLK1 input. When LOW, selects CLK0, nCLK0 inputs. LVTTTL / LVCMOS interface levels.
4	CLK0	Input	Pulldown	Non-inverting differential clock input.
5	nCLK0	Input	Pullup/ Pulldown	Inverting differential clock input.
6	CLK1	Input	Pulldown	Single-ended clock input. LVTTTL / LVCMOS interface levels.
7, 8	nc	Unused		No connect.
9	IREF	Input		An external fixed precision resistor (475Ω) from this pin to ground provides a reference current used for differential current-mode Qx/nQx outputs.
10, 13, 18	V _{DD}	Power		Positive supply pins.
11, 12	nQ3, Q3	Output		Differential output pair. HCSL interface levels.
14, 15	nQ2, Q2	Output		Differential output pair. HCSL interface levels.
16, 17	nQ1, Q1	Output		Differential output pair. HCSL interface levels.
19, 20	nQ0, Q0	Output		Differential output pair. HCSL interface levels.

NOTE: *Pullup* and *Pulldown* refer to internal input resistors. See Table 2, Pin Characteristics, for typical values.

TABLE 2. PIN CHARACTERISTICS

Symbol	Parameter	Test Conditions	Minimum	Typical	Maximum	Units
C _{IN}	Input Capacitance			4		pF
R _{PULLUP}	Input Pullup Resistor			51		kΩ
R _{PULLDOWN}	Input Pulldown Resistor			51		kΩ

TABLE 3. CONTROL INPUT FUNCTION TABLE

Inputs			Outputs	
CLK_EN	CLK_SEL	Selected Source	Q0:Q3	nQ0:nQ3
0	0	CLK0, nCLK0	Disabled; LOW	Disabled; HIGH
0	1	CLK1	Disabled; LOW	Disabled; HIGH
1	0	CLK0, nCLK0	Enabled	Enabled
1	1	CLK1	Enabled	Enabled

After CLK_EN switches, the clock outputs are disabled or enabled following a falling input clock edge as shown in Figure 1.

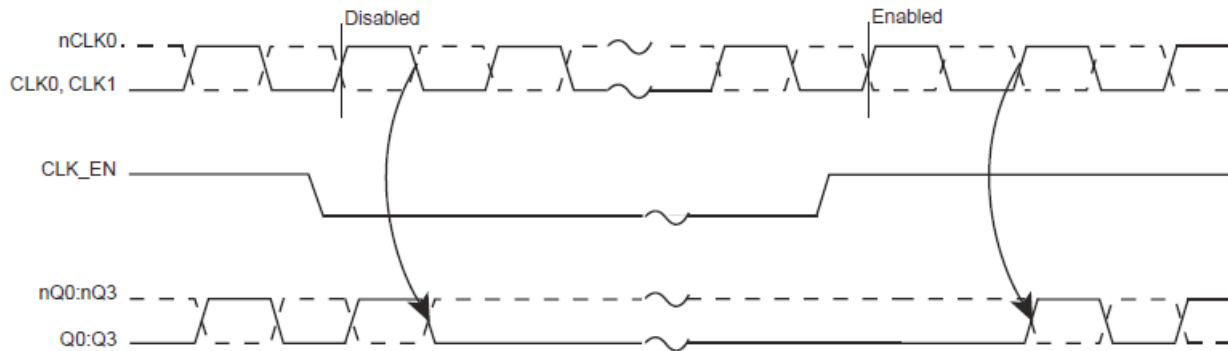

FIGURE 1. CLK_EN TIMING DIAGRAM

ABSOLUTE MAXIMUM RATINGS

Supply Voltage, V_{DD}	4.6V
Inputs, V_I	-0.5V to $V_{DD} + 0.5V$
Outputs, I_O	-0.5V to $V_{DD} + 0.5V$
Package Thermal Impedance, θ_{JA}	91.1°C/W (0 mps)
Storage Temperature, T_{STG}	-65°C to 150°C

NOTE: Stresses beyond those listed under Absolute Maximum Ratings may cause permanent damage to the device. These ratings are stress specifications only. Functional operation of product at these conditions or any conditions beyond those listed in the *DC Characteristics* or *AC Characteristics* is not implied. Exposure to absolute maximum rating conditions for extended periods may affect product reliability.

TABLE 4A. POWER SUPPLY DC CHARACTERISTICS, $V_{DD} = 3.3V \pm 10\%$, $T_A = -40^\circ\text{C}$ TO 85°C

Symbol	Parameter	Test Conditions	Minimum	Typical	Maximum	Units
V_{DD}	Positive Supply Voltage		2.97	3.3	3.63	V
I_{DD}	Power Supply Current	Unterminated			27	mA

TABLE 4B. LVCMOS / LVTTTL DC CHARACTERISTICS, $V_{DD} = 3.3V \pm 10\%$, $T_A = -40^\circ\text{C}$ TO 85°C

Symbol	Parameter	Test Conditions	Minimum	Typical	Maximum	Units
V_{IH}	Input High Voltage		2		$V_{DD} + 0.3$	V
V_{IL}	Input Low Voltage		-0.3		0.8	V
I_{IH}	Input High Current	CLK1, CLK_SEL	$V_{IN} = V_{DD} = 3.63V$		150	μA
		CLK_EN	$V_{IN} = V_{DD} = 3.63V$		5	μA
I_{IL}	Input Low Current	CLK1, CLK_SEL	$V_{IN} = 0V, V_{DD} = 3.63V$	-5		μA
		CLK_EN	$V_{IN} = 0V, V_{DD} = 3.63V$	-150		μA

TABLE 4C. DIFFERENTIAL DC CHARACTERISTICS, $V_{DD} = 3.3V \pm 10\%$, $T_A = -40^\circ\text{C}$ TO 85°C

Symbol	Parameter	Test Conditions	Minimum	Typical	Maximum	Units
I_{IH}	Input High Current	CLK0/nCLK0	$V_{DD} = V_{IN} = 3.63V$		150	μA
I_{IL}	Input Low Current	CLK0	$V_{DD} = 3.63V, V_{IN} = 0V$	-5		μA
		nCLK0	$V_{DD} = 3.63V, V_{IN} = 0V$	-150		μA
V_{PP}	Peak-to-Peak Input Voltage; NOTE 1		0.15		1.3	V
V_{CMR}	Common Mode Input Voltage; NOTE 1, 2		GND + 0.5		$V_{DD} - 0.85$	V

NOTE 1: V_{IL} should not be less than -0.3V.

NOTE 2: Common mode voltage is defined as V_{IH} .

TABLE 5. AC CHARACTERISTICS, $V_{DD} = 3.3V \pm 10\%$, $T_A = -40^\circ C$ TO $85^\circ C$

Symbol	Parameter	Test Conditions	Minimum	Typical	Maximum	Units
f_{OUT}	Output Frequency	CLK_SEL = 0			500	MHz
		CLK_SEL = 1			250	MHz
t_{PD}	Propagation Delay; NOTE 1	CLK_SEL = 0	2.0		3.2	ns
		CLK_SEL = 1	2.0		2.8	ns
$tsk(o)$	Output Skew; NOTE 2, 4				100	ps
$tsk(pp)$	Part-to-Part Skew; NOTE 3, 4				600	ps
t_{jit}	Buffer Additive Phase Jitter, RMS; refer to Additive Phase Jitter Section	100MHz, (12kHz - 20MHz)		0.22		ps
V_{MAX}	Absolute Maximum Output Voltage; NOTE 5, 10				1150	mV
V_{MIN}	Absolute Minimum Output Voltage; NOTE 5, 11		-300			mV
V_{RB}	Ringback Voltage; NOTE 6, 13		-100		100	mV
t_{STABLE}	Time before V_{RB} is allowed; NOTE 6, 13		500			ps
V_{CROSS}	Absolute Crossing Voltage; NOTE 5, 8, 9		250		550	mV
DV_{CROSS}	Total Variation of V_{CROSS} over all edges; NOTE 5, 8, 12				140	mV
	Rise/Fall Edge Rate; NOTE 6, 7	Measured between -150mV to +150mV	0.6		5.5	V/ns
odc	Output Duty Cycle; NOTE 14		45		55	%

NOTE: Electrical parameters are guaranteed over the specified ambient operating temperature range, which is established when the device is mounted in a test socket with maintained transverse airflow greater than 500 lfm. The device will meet specifications after thermal equilibrium has been reached under these conditions.

NOTE: All parameters measured at $f_{out} \leq 250\text{MHz}$ unless noted otherwise.

NOTE 1: Measured from the $V_{DD}/2$ of the input to the differential output crossing point.

NOTE 2: Defined as skew between outputs at the same supply voltage and with equal load conditions. Measured at the output differential cross points.

NOTE 3: Defined as skew between outputs on different devices operating at the same supply voltage, same temperature, and with equal load conditions. Using the same type of inputs on each device, the outputs are measured at the differential cross points.

NOTE 4: This parameter is defined in accordance with JEDEC Standard 65.

NOTE 5: Measurement taken from single-ended waveform.

NOTE 6: Measurement taken from differential waveform.

NOTE 7: Measured from -150mV to +150mV on the differential waveform (derived from Qx minus nQx). The signal must be monotonic through the measurement region for rise and fall time. The 300mV measurement window is centered on the differential zero crossing. See Parameter Measurement Information Section.

NOTE 8: Measured at crossing point where the instantaneous voltage value of the rising edge of Qx equals the falling edge of nQx. See Parameter Measurement Information Section.

NOTE 9: Refers to the total variation from the lowest crossing point to the highest, regardless of which edge is crossing. Refers to all crossing points for this measurement. See Parameter Measurement Information Section.

NOTE 10: Defined as the maximum instantaneous voltage including overshoot. See Parameter Measurement Information Section.

NOTE 11: Defined as the minimum instantaneous voltage including undershoot. See Parameter Measurement Information Section.

NOTE 12: Defined as the total variation of all crossing voltage of Rising Qx and Falling nQx. This is the maximum allowed variance in the V_{CROSS} for any particular system. See Parameter Measurement Information Section.

NOTE: 13. T_{STABLE} is the time the differential clock must maintain a minimum $\pm 150\text{mV}$ differential voltage after rising/falling edges before it is allowed to droop back into the $V_{RB} \pm 100\text{mV}$ differential range. See Parameter Measurement Information Section.

NOTE 14: Input duty cycle must be 50%.

ADDITIVE PHASE JITTER

The spectral purity in a band at a specific offset from the fundamental compared to the power of the fundamental is called the **dBc Phase Noise**. This value is normally expressed using a Phase noise plot and is most often the specified plot in many applications. Phase noise is defined as the ratio of the noise power present in a 1Hz band at a specified offset from the fundamental frequency to the power value of the fundamental. This ratio is expressed in decibels

(dBm) or a ratio of the power in the 1Hz band to the power in the fundamental. When the required offset is specified, the phase noise is called a **dBc** value, which simply means dBm at a specified offset from the fundamental. By investigating jitter in the frequency domain, we get a better understanding of its effects on the desired application over the entire time record of the signal. It is mathematically possible to calculate an expected bit error rate given a phase noise plot.

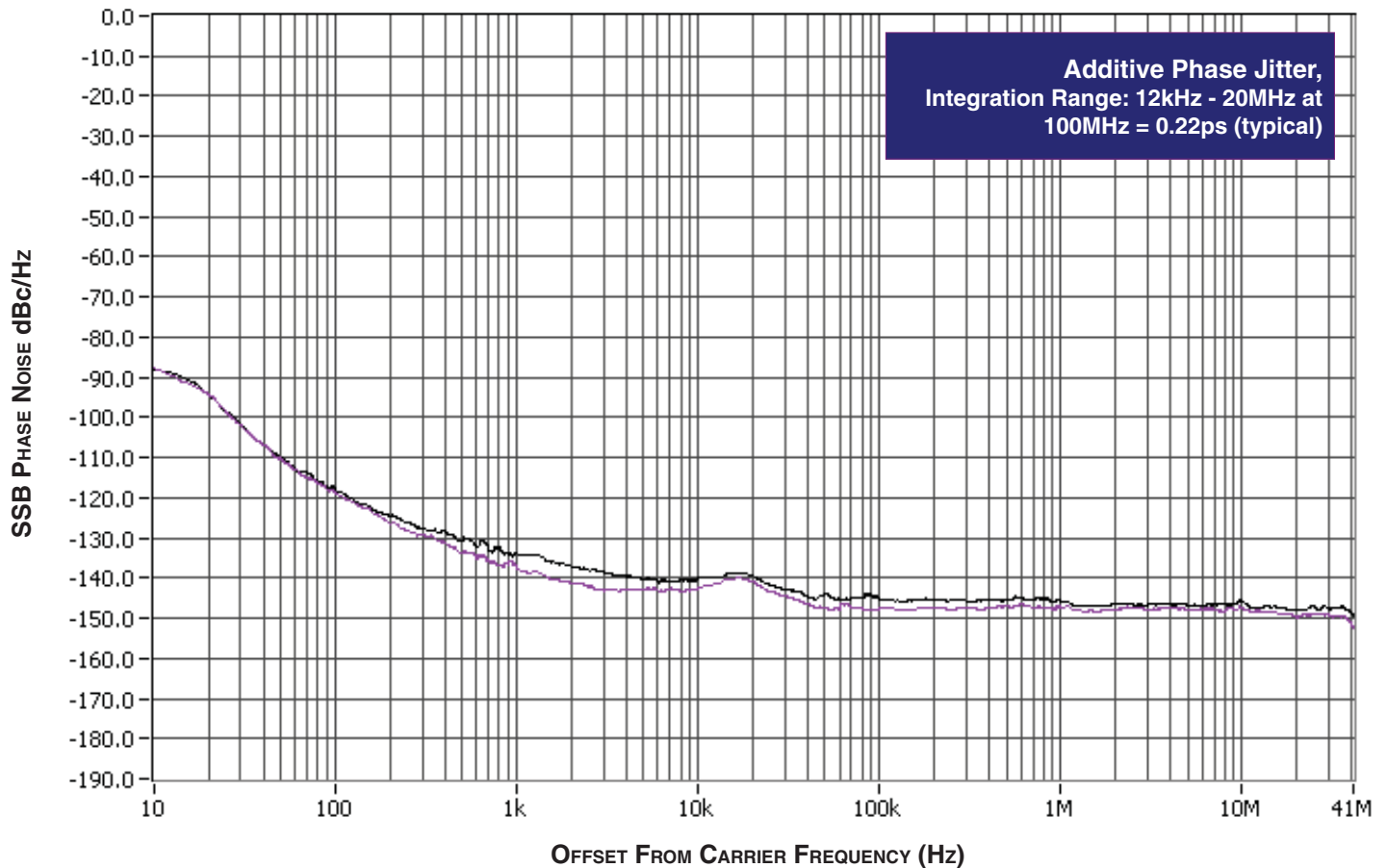

As with most timing specifications, phase noise measurements has issues relating to the limitations of the equipment. Often the noise floor of the equipment is higher than the noise floor of the device.

This is illustrated above. The device meets the noise floor of what is shown, but can actually be lower. The phase noise is dependent on the input source and measurement equipment.

PARAMETER MEASUREMENT INFORMATION

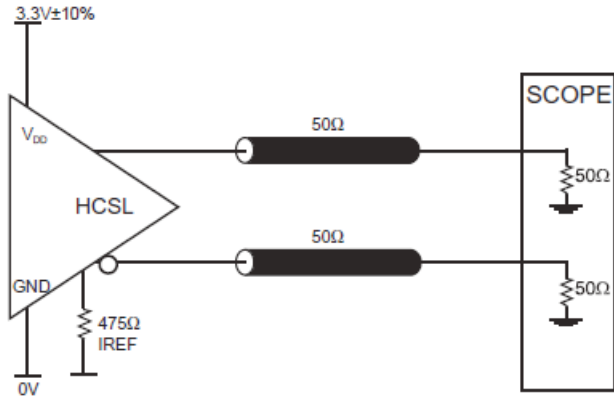

This load condition is used for I_{out} , $f_{sk}(o)$, t_{pd} , and f_{jit} measurements.

HCSL OUTPUT LOAD AC TEST CIRCUIT

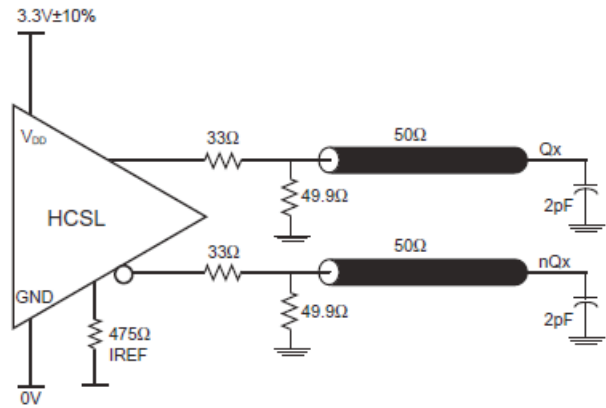

HCSL OUTPUT LOAD AC TEST CIRCUIT

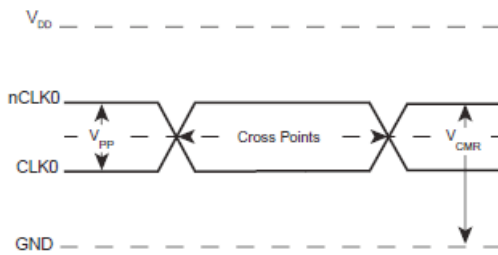

DIFFERENTIAL INPUT LEVELS

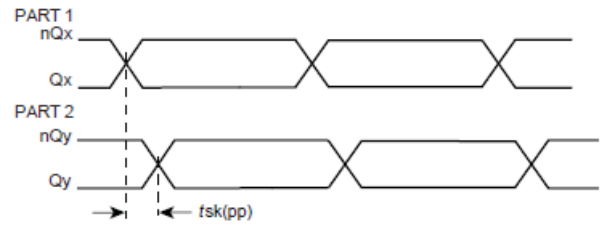

PART-TO-PART SKEW

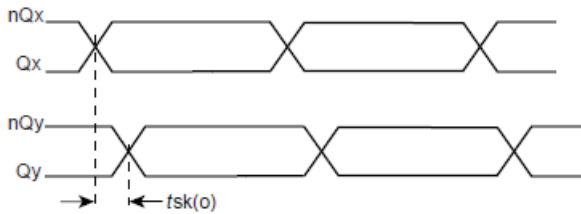

OUTPUT SKEW (DIFFERENTIAL INPUT)

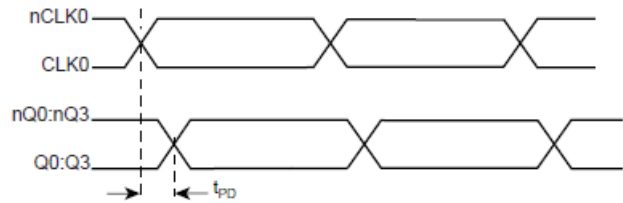

PROPAGATION DELAY (DIFFERENTIAL INPUTS)

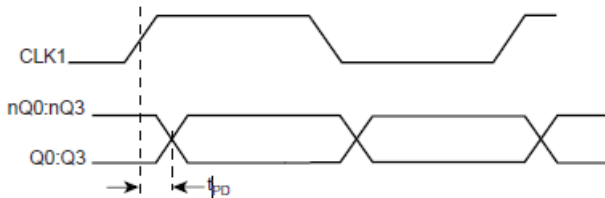

PROPAGATION DELAY (LVCMOS INPUT)

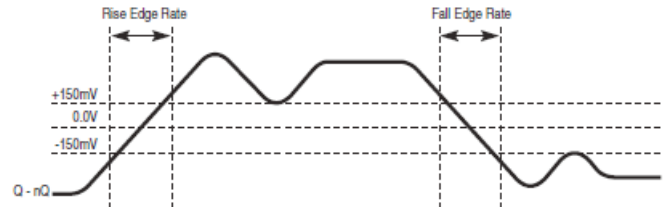

DIFFERENTIAL MEASUREMENT POINTS FOR RISE/FALL TIME

PARAMETER MEASUREMENT INFORMATION, CONTINUED

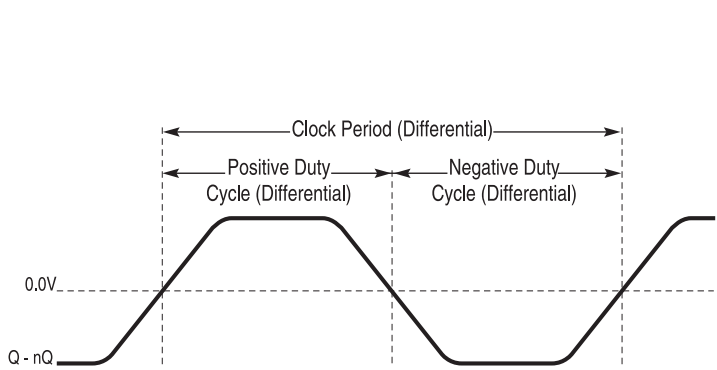

DIFFERENTIAL MEASUREMENT POINTS FOR DUTY CYCLE/PERIOD

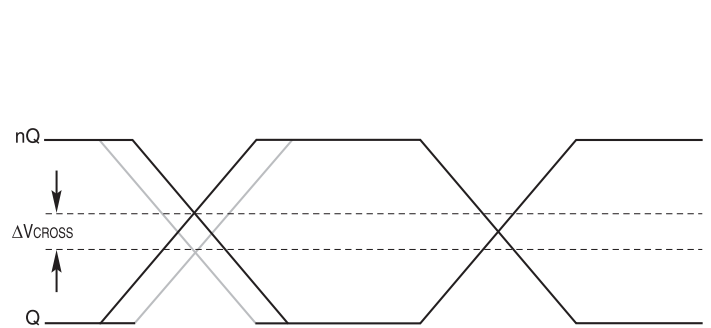

SINGLE-ENDED MEASUREMENT POINTS FOR DELTA CROSS POINT

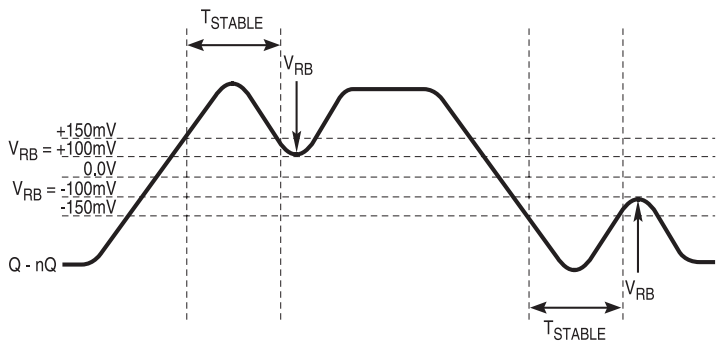

DIFFERENTIAL MEASUREMENT POINTS FOR RINGBACK

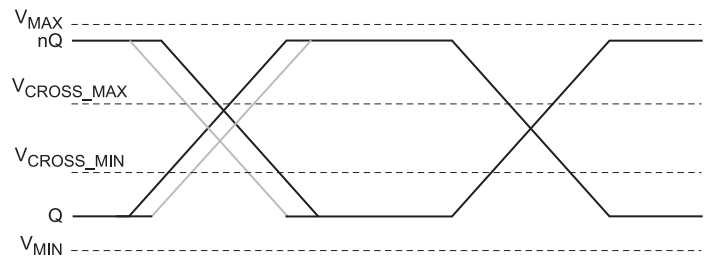

SINGLE-ENDED MEASUREMENT POINTS FOR ABSOLUTE CROSS POINT/SWING

APPLICATIONS INFORMATION

RECOMMENDATIONS FOR UNUSED INPUT AND OUTPUT PINS

INPUTS:

CLK INPUT

For applications not requiring the use of a clock input, it can be left floating. Though not required, but for additional protection, a 1kΩ resistor can be tied from the CLK input to ground.

CLK/nCLK INPUTS

For applications not requiring the use of the differential input, both CLK and nCLK can be left floating. Though not required, but for additional protection, a 1kΩ resistor can be tied from CLK to ground.

LVCN05 CONTROL PINS

All control pins have internal pull-ups or pull-downs; additional resistance is not required but can be added for additional protection. A 1kΩ resistor can be used.

OUTPUTS:

DIFFERENTIAL OUTPUTS

All unused differential outputs can be left floating. We recommend that there is no trace attached. Both sides of the differential output pair should either be left floating or terminated.

WIRING THE DIFFERENTIAL INPUT TO ACCEPT SINGLE ENDED LEVELS

Figure 2 shows how a differential input can be wired to accept single ended levels. The reference voltage $V_{REF} = V_{DD}/2$ is generated by the bias resistors R1 and R2. The bypass capacitor (C1) is used to help filter noise on the DC bias. This bias circuit should be located as close to the input pin as possible. The ratio of R1 and R2 might need to be adjusted to position the V_{REF} in the center of the input voltage swing. For example, if the input clock swing is 2.5V and $V_{DD} = 3.3V$, R1 and R2 value should be adjusted to set V_{REF} at 1.25V. The values below are for when both the single-ended swing and V_{DD} are at the same voltage. This configuration requires that the sum of the output impedance of the driver (R_o) and the series resistance (R_s) equals the transmission line impedance. In addition, matched termination at the input will attenuate the signal in half. This can be done in one of two ways. First, R3 and R4 in parallel should equal the

transmission line impedance. For most 50 applications, R3 and R4 can be 100Ω. The values of the resistors can be increased to reduce the loading for slower and weaker LVCN05 driver. When using single ended signaling, the noise rejection benefits of differential signaling are reduced. Even though the differential input can handle full rail LVCN05 signaling, it is recommended that the amplitude be reduced. The datasheet specifies a lower differential amplitude, however this only applies to differential signals. For single-ended applications, the swing can be larger, however V_L cannot be less than -0.3V and V_H cannot be more than $V_{DD} + 0.3V$. Though some of the recommended components might not be used, the pads should be placed in the layout. They can be utilized for debugging purposes. The datasheet specifications are characterized and guaranteed by using a differential signal.

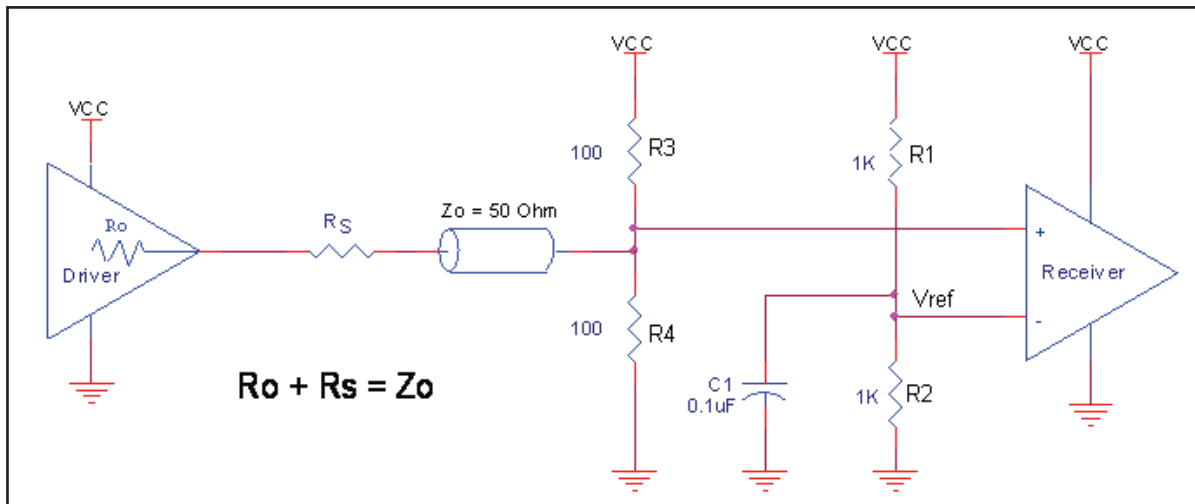

FIGURE 2. SINGLE ENDED SIGNAL DRIVING DIFFERENTIAL INPUT

DIFFERENTIAL CLOCK INPUT INTERFACE

The CLK/nCLK accepts LVDS, LVPECL, LVHSTL, HCSL and other differential signals. Both differential signals must meet the V_{PP} and V_{CMR} input requirements. Figures 3A to 3E show interface examples for the CLK/nCLK input driven by the most common driver types. The input interfaces suggested here are examples only. Please

consult with the vendor of the driver component to confirm the driver termination requirements. For example in Figure 3A, the input termination applies for IDT open emitter LVHSTL drivers. If you are using an LVHSTL driver from another vendor, use their termination

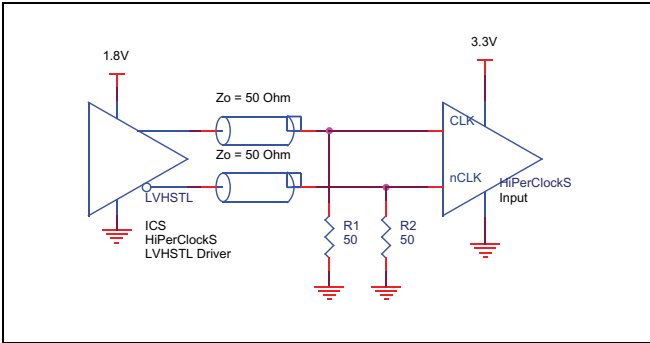

FIGURE 3A. CLK/nCLK INPUT DRIVEN BY AN IDT OPEN EMITTER LVHSTL DRIVER

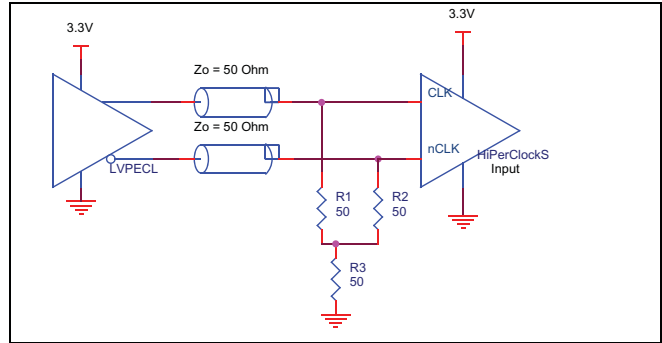

FIGURE 3B. CLK/nCLK INPUT DRIVEN BY A 3.3V LVPECL DRIVER

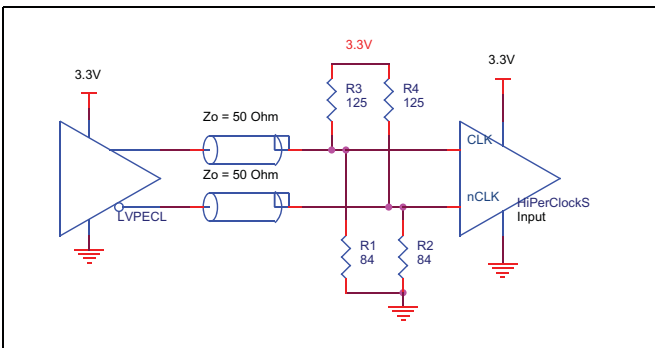

FIGURE 3C. CLK/nCLK INPUT DRIVEN BY A 3.3V LVPECL DRIVER

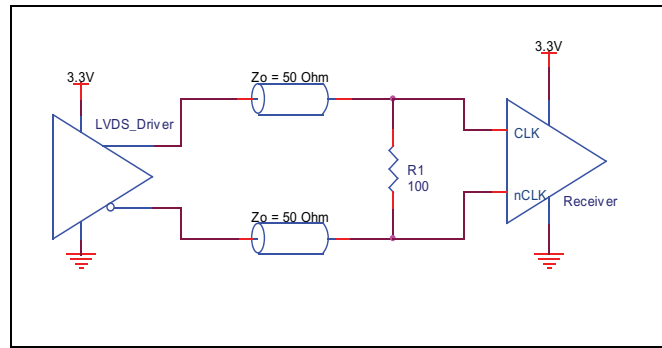

FIGURE 3D. CLK/nCLK INPUT DRIVEN BY A 3.3V LVDS DRIVER

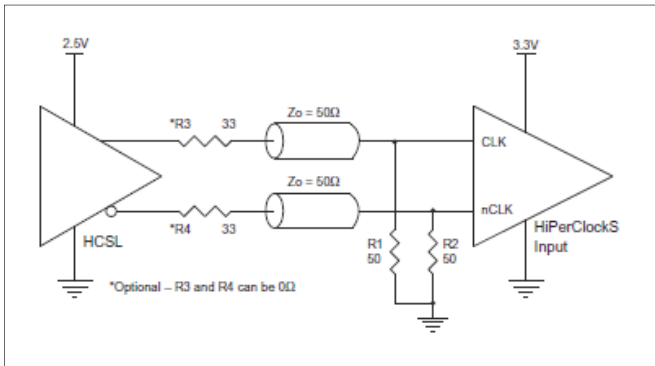

FIGURE 3E. CLK/nCLK INPUT DRIVEN BY A 3.3V HCSL DRIVER

RECOMMENDED TERMINATION

Figure 4A is the recommended source termination for applications where the driver and receiver will be on separate PCBs. This termination is the standard for PCI Express and

HCSL output types. All traces should be 50Ω impedance single ended or 100Ω differential.

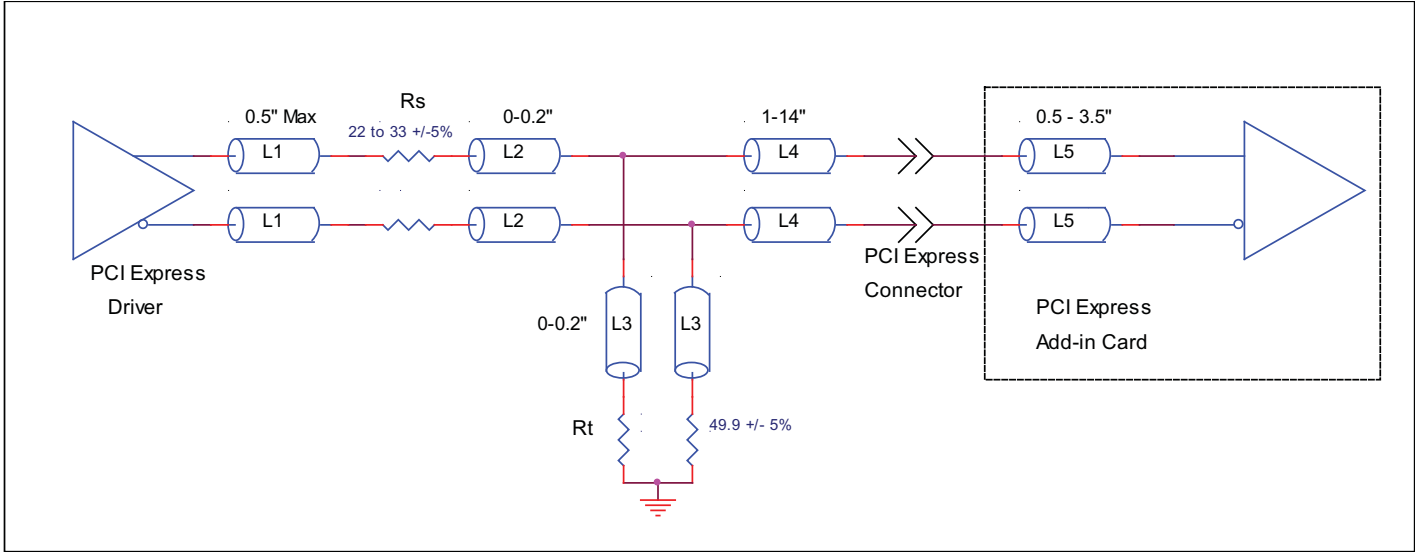

FIGURE 4A. RECOMMENDED TERMINATION

Figure 4B is the recommended termination for applications where a point-to-point connection can be used. A point-to-point connection contains both the driver and the receiver on the same PCB. With a matched termination at the receiver, transmission-line reflections will be minimized. In addition, a series resistor

(Rs) at the driver offers flexibility and can help dampen unwanted reflections. The optional resistor can range from 0Ω to 33Ω. All traces should be 50Ω impedance single ended or 100Ω differential.

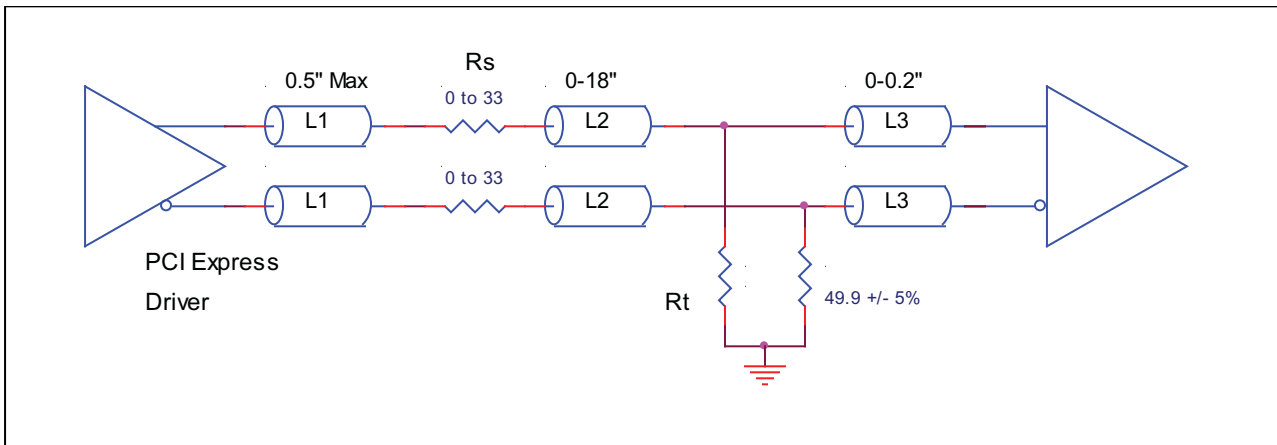

FIGURE 4B. RECOMMENDED TERMINATION

POWER CONSIDERATIONS

This section provides information on power dissipation and junction temperature for the 85104I. Equations and example calculations are also provided.

1. Power Dissipation.

The total power dissipation for the 85104I is the sum of the core power plus the power dissipated in the load(s). The following is the power dissipation for $V_{DD} = 3.3V + 10\% = 3.63V$, which gives worst case results.

NOTE: Please refer to Section 3 for details on calculating power dissipated in the load.

- Power (core)_{MAX} = $V_{DD_MAX} * I_{DD_MAX} = 3.63V * 27mA = 98.01mW$
- Power (outputs)_{MAX} = **47.3mW/Loaded Output pair**
If all outputs are loaded, the total power is $4 * 47.3mW = 189.2mW$

$$\text{Total Power}_{_MAX} \text{ (3.63V, with all outputs switching)} = 98.01mW + 189.2mW = 287.21mW$$

2. Junction Temperature.

Junction temperature at the junction of the bond wire and bond pad directly affects the reliability of the device. The maximum recommended junction temperature is 125°C. Limiting the internal transistor junction temperature, T_j, to 125°C ensures that the bond wire and bond pad temperature remains below 125°C.

The equation for T_j is as follows: $T_j = \theta_{JA} * Pd_total + T_A$

T_j = Junction Temperature

θ_{JA} = Junction-to-Ambient Thermal Resistance

Pd_{total} = Total Device Power Dissipation (example calculation is in Section 1 above)

T_A = Ambient Temperature

In order to calculate junction temperature, the appropriate junction-to-ambient thermal resistance θ_{JA} must be used. Assuming no air flow and a multi-layer board, the appropriate value is 91.1°C/W per Table 6 below.

Therefore, T_j for an ambient temperature of 85°C with all outputs switching is:
 $85°C + 0.287W * 91.1°C/W = 111.1°C$. This is below the limit of 125°C.

This calculation is only an example. T_j will obviously vary depending on the number of loaded outputs, supply voltage, air flow, and the type of board (multi-layer).

TABLE 6. THERMAL RESISTANCE θ_{JA} FOR 20-LEADN TSSOP, FORCED CONVECTION

	θ_{JA} by Velocity (Meters per Second)		
	0	1	2.5
Multi-Layer PCB, JEDEC Standard Test Boards	91.1°C/W	86.7°C/W	84.6°C/W

3. Calculations and Equations.

The purpose of this section is to calculate power dissipation on the IC per HCSL output pair.

HCSL output driver circuit and termination are shown in Figure 5.

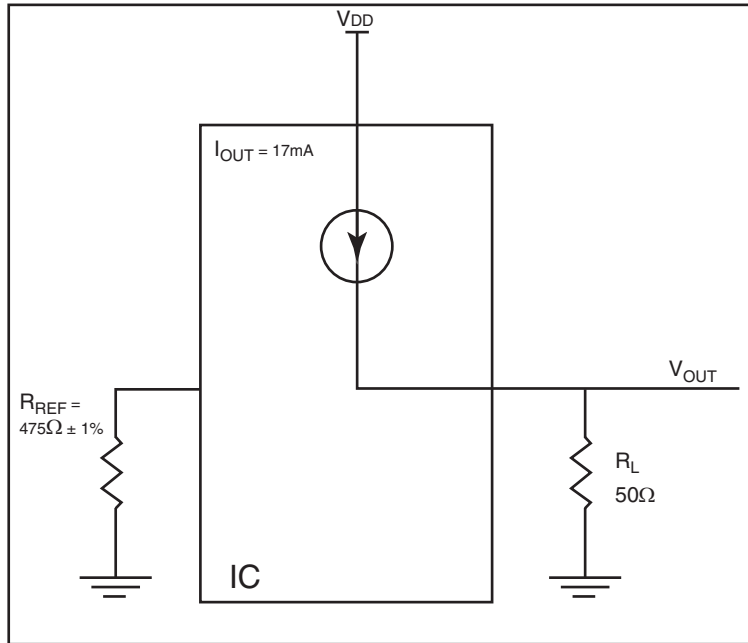

FIGURE 5. HCSL DRIVER CIRCUIT AND TERMINATION

HCSL is a current steering output which sources a maximum of 17mA of current per output. To calculate worst case on-chip power dissipation, use the following equations which assume a 50Ω load to ground.

The highest power dissipation occurs when V_{DD} is HIGH.

$$\begin{aligned} \text{Power} &= (V_{DD,HIGH} - V_{OUT}) * I_{OUT}, \text{ since } V_{OUT} = I_{OUT} * R_L \\ &= (V_{DD,HIGH} - I_{OUT} * R_L) * I_{OUT} \\ &= (3.63V - 17mA * 50\Omega) * 17mA \end{aligned}$$

Total Power Dissipation per output pair = **47.3mW**

RELIABILITY INFORMATION

TABLE 7. θ_{JA} vs. AIR FLOW TABLE FOR 20 LEAD TSSOP

θ_{JA} by Velocity (Meters per Second)			
	0	1	2.5
Multi-Layer PCB, JEDEC Standard Test Boards	91.1°C/W	86.7°C/W	84.6°C/W

TRANSISTOR COUNT

The transistor count for 85104I is: 614

PACKAGE OUTLINE AND DIMENSIONS

PACKAGE OUTLINE - G SUFFIX FOR 20 LEAD TSSOP

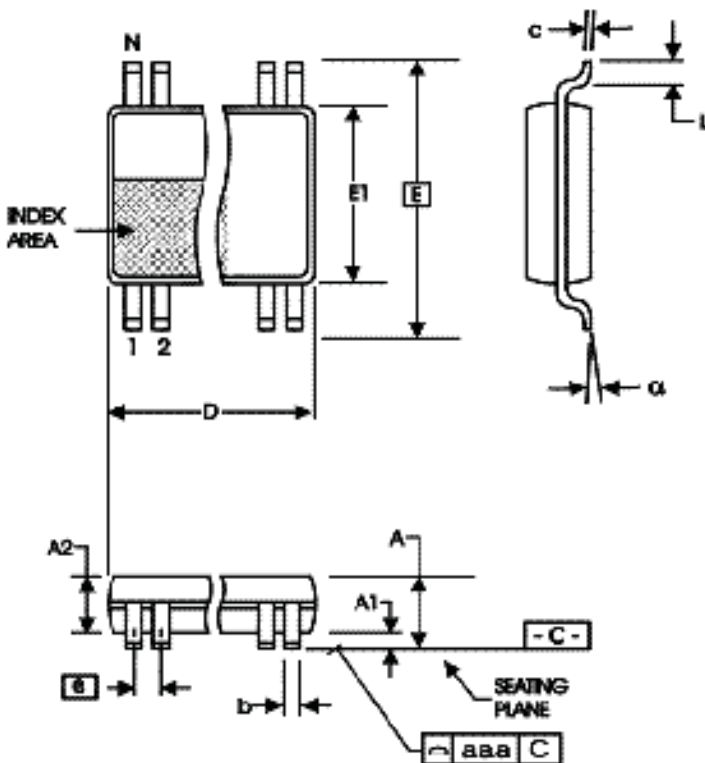

TABLE 8. PACKAGE DIMENSIONS

SYMBOL	Millimeters	
	Minimum	Maximum
N	20	
A	--	1.20
A1	0.05	0.15
A2	0.80	1.05
b	0.19	0.30
c	0.09	0.20
D	6.40	6.60
E	6.40 BASIC	
E1	4.30	4.50
e	0.65 BASIC	
L	0.45	0.75
α	0°	8°
aaa	--	0.10

Reference Document: JEDEC Publication 95, MO-153

TABLE 9 ORDERING INFORMATION

Part/Order Number	Marking	Package	Shipping Packaging	Temperature
85104AGILF	ICS85104AGIL	20 lead "Lead Free" TSSOP	Tube	-40°C to +85°C
85104AGILFT	ICS85104AGIL	20 lead "Lead Free" TSSOP	Tape and Reel	-40°C to +85°C

REVISION HISTORY SHEET				
Rev	Table	Page	Description of Change	Date
A	T5	5 9 11	AC Characteristics Table - corrected units for V_{RB} from V to mV. Updated Wiring the Differential Levels to Accept Single-ended Levels application note. Updated Recommended Termination application note.	5/27/11
A	T9	1 15	Remove ICS from the part numbers where needed. Features Section - removed reference to the lead free parts. Ordering Information - removed quantity in tape and reel. Deleted LF note below the table. Update header and footer.	1/20/16

IMPORTANT NOTICE AND DISCLAIMER

RENESAS ELECTRONICS CORPORATION AND ITS SUBSIDIARIES (“RENESAS”) PROVIDES TECHNICAL SPECIFICATIONS AND RELIABILITY DATA (INCLUDING DATASHEETS), DESIGN RESOURCES (INCLUDING REFERENCE DESIGNS), APPLICATION OR OTHER DESIGN ADVICE, WEB TOOLS, SAFETY INFORMATION, AND OTHER RESOURCES “AS IS” AND WITH ALL FAULTS, AND DISCLAIMS ALL WARRANTIES, EXPRESS OR IMPLIED, INCLUDING, WITHOUT LIMITATION, ANY IMPLIED WARRANTIES OF MERCHANTABILITY, FITNESS FOR A PARTICULAR PURPOSE, OR NON-INFRINGEMENT OF THIRD-PARTY INTELLECTUAL PROPERTY RIGHTS.

These resources are intended for developers who are designing with Renesas products. You are solely responsible for (1) selecting the appropriate products for your application, (2) designing, validating, and testing your application, and (3) ensuring your application meets applicable standards, and any other safety, security, or other requirements. These resources are subject to change without notice. Renesas grants you permission to use these resources only to develop an application that uses Renesas products. Other reproduction or use of these resources is strictly prohibited. No license is granted to any other Renesas intellectual property or to any third-party intellectual property. Renesas disclaims responsibility for, and you will fully indemnify Renesas and its representatives against, any claims, damages, costs, losses, or liabilities arising from your use of these resources. Renesas' products are provided only subject to Renesas' Terms and Conditions of Sale or other applicable terms agreed to in writing. No use of any Renesas resources expands or otherwise alters any applicable warranties or warranty disclaimers for these products.

(Disclaimer Rev.1.01 Jan 2024)

Corporate Headquarters

TOYOSU FORESIA, 3-2-24 Toyosu,
Koto-ku, Tokyo 135-0061, Japan
www.renesas.com

Trademarks

Renesas and the Renesas logo are trademarks of Renesas Electronics Corporation. All trademarks and registered trademarks are the property of their respective owners.

Contact Information

For further information on a product, technology, the most up-to-date version of a document, or your nearest sales office, please visit www.renesas.com/contact-us/.