

LMV722-Q1 10-MHz Low-Noise, Low-Voltage Operational Amplifier

1 Features

- Qualified for Automotive Applications
- AEC-Q100 Qualified With the Following Results:
 - Device Ambient Operating Temperature: -40°C to $+125^{\circ}\text{C}$
 - Device HBM ESD Classification Level 2
 - Device CDM ESD Classification Level C4B
- Power-Supply Voltage Range: 2.2 V to 5.5 V
- Low Supply Current: 905 μA /Amplifier at 2.2 V
- High Unity-Gain Bandwidth: 10 MHz
- Rail-to-Rail Output Swing
 - 600- Ω Load: 120 mV From Either Rail at 2.2 V
 - 2-k Ω Load: 50 mV From Either Rail at 2.2 V
- Input Common-Mode Voltage Range Includes Ground
- Input Voltage Noise: 10.5 nV/ $\sqrt{\text{Hz}}$ at $f = 1$ kHz

2 Applications

- Infotainment
- Engine Control Unit
- Automotive Lighting
- Audio Signal Path

3 Description

The LMV722-Q1 device is a low-noise, low-voltage operational amplifier (op amp) that can be designed into a wide range of applications. The LMV722-Q1 has a unity-gain bandwidth of 10 MHz, slew rate of 5.25 V/ μs , and good voltage and current noise performance.

The LMV722-Q1 is designed to provide optimal performance in low-voltage and low-noise systems such audio signal path or motor control applications. The device provides rail-to-rail output swing into heavy loads. The input common-mode voltage range includes ground and the maximum input offset voltage is 3.5 mV (over recommended temperature range) for the device. The capacitive load capability is also good at low supply voltages. The operating range is from 2.2 V to 5.5 V.

Device Information⁽¹⁾

| PART NUMBER | PACKAGE | BODY SIZE (NOM) |
|-------------|---------|-------------------|
| LMV722-Q1 | VSSOP | 3.00 mm x 3.00 mm |

(1) For all available packages, see the orderable addendum at the end of the data sheet.

Simplified Schematic

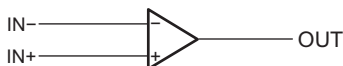

Table of Contents

| | | | |
|---------------------------------------------------------------|-----------|------------------------------------------------------------------|-----------|
| 1 Features | 1 | 7.4 Device Functional Modes..... | 12 |
| 2 Applications | 1 | 8 Application and Implementation | 13 |
| 3 Description | 1 | 8.1 Application Information..... | 13 |
| 4 Revision History | 2 | 8.2 Typical Application | 13 |
| 5 Pin Configuration and Functions | 3 | 9 Power Supply Recommendations | 15 |
| 6 Specifications | 4 | 9.1 Input and ESD Protection | 15 |
| 6.1 Absolute Maximum Ratings | 4 | 10 Layout | 16 |
| 6.2 ESD Ratings..... | 4 | 10.1 Layout Guidelines | 16 |
| 6.3 Recommended Operating Conditions..... | 4 | 10.2 Layout Example | 17 |
| 6.4 Thermal Information | 4 | 11 Device and Documentation Support | 18 |
| 6.5 Electrical Characteristics $V_{CC+} = 2.2\text{ V}$ | 5 | 11.1 Documentation Support | 18 |
| 6.6 Electrical Characteristics $V_{CC+} = 5\text{ V}$ | 6 | 11.2 Receiving Notification of Documentation Updates | 18 |
| 6.7 Typical Characteristics..... | 7 | 11.3 Community Resources..... | 18 |
| 7 Detailed Description | 12 | 11.4 Trademarks | 18 |
| 7.1 Overview | 12 | 11.5 Electrostatic Discharge Caution..... | 18 |
| 7.2 Functional Block Diagram | 12 | 11.6 Glossary | 18 |
| 7.3 Feature Description..... | 12 | 12 Mechanical, Packaging, and Orderable Information | 18 |

4 Revision History

| Changes from Original (June 2017) to Revision A | Page |
|---------------------------------------------------|-----------|
| • Changed body size from 4.90 mm to 3.00 mm | 1 |
| • CDM value changed from 100 V to 1000 V..... | 4 |
| • Updated <i>Layout Example</i> section | 17 |

5 Pin Configuration and Functions

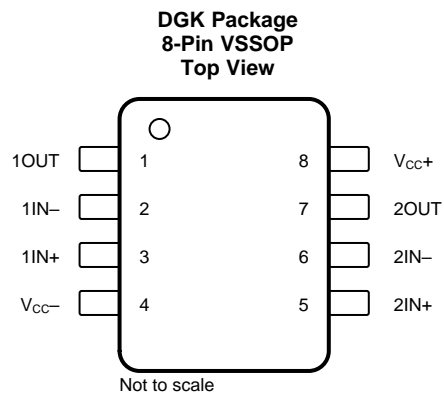

Pin Functions

| PIN | | I/O | DESCRIPTION |
|-----|------------------|-----|------------------------------------|
| NO. | NAME | | |
| 1 | 1OUT | O | Output of amplifier 1 |
| 2 | 1IN– | I | Inverting input of amplifier 1 |
| 3 | 1IN+ | I | Non-inverting input of amplifier 1 |
| 4 | V _{CC–} | I | Negative power supply |
| 5 | 2IN+ | I | Non-inverting input of amplifier 2 |
| 6 | 2IN– | I | Inverting input of amplifier 2 |
| 7 | 2OUT | O | Output of amplifier 2 |
| 8 | V _{CC+} | I | Positive power supply |

6 Specifications

6.1 Absolute Maximum Ratings

 over operating free-air temperature range (unless otherwise noted)⁽¹⁾

| | | MIN | MAX | UNIT |
|---------------------|-------------------------------------------|-----|-----------------|------|
| $V_{CC+} - V_{CC-}$ | Supply voltage ⁽²⁾ | 0 | 6 | V |
| V_{ID} | Differential input voltage ⁽³⁾ | | ±Supply voltage | V |
| T_J | Operating virtual-junction temperature | | 150 | °C |
| T_{stg} | Storage temperature | -65 | 150 | °C |

- (1) Stresses beyond those listed under *Absolute Maximum Ratings* may cause permanent damage to the device. These are stress ratings only, which do not imply functional operation of the device at these or any other conditions beyond those indicated under *Recommended Operating Conditions*. Exposure to absolute-maximum-rated conditions for extended periods may affect device reliability.
- (2) All voltage values (except differential voltages and V_{CC} specified for the measurement of I_{OS}) are with respect to the network GND.
- (3) Differential voltages are at IN+ with respect to IN-.

6.2 ESD Ratings

| | | VALUE | UNIT |
|-------------|-------------------------|---------------------------------------------------------|------|
| $V_{(ESD)}$ | Electrostatic discharge | Human-body model (HBM), per AEC Q100-002 ⁽¹⁾ | 2000 |
| | | Charged-device model (CDM), per AEC Q100-011 | 1000 |

- (1) AEC Q100-002 indicates that HBM stressing shall be in accordance with the ANSI/ESDA/JEDEC JS-001 specification.

6.3 Recommended Operating Conditions

over operating free-air temperature range (unless otherwise noted)

| | | MIN | MAX | UNIT |
|---------------------|-------------------------------|-----|-----|------|
| $V_{CC+} - V_{CC-}$ | Supply voltage | 2.2 | 5.5 | V |
| T_J | Operating ambient temperature | -40 | 125 | °C |

6.4 Thermal Information

| THERMAL METRIC ⁽¹⁾ | | LMV722-Q1 | UNIT |
|-------------------------------|----------------------------------------------|-------------|------|
| | | DGK (VSSOP) | |
| | | 8 PINS | |
| $R_{\theta JA}$ | Junction-to-ambient thermal resistance | 176.3 | °C/W |
| $R_{\theta JC(top)}$ | Junction-to-case (top) thermal resistance | 69.5 | °C/W |
| $R_{\theta JB}$ | Junction-to-board thermal resistance | 97.7 | °C/W |
| Ψ_{JT} | Junction-to-top characterization parameter | 12.7 | °C/W |
| Ψ_{JB} | Junction-to-board characterization parameter | 96.3 | °C/W |
| $R_{\theta JC(bot)}$ | Junction-to-case (bottom) thermal resistance | n/a | °C/W |

- (1) For more information about traditional and new thermal metrics, see the [Semiconductor and IC Package Thermal Metrics](#) application report.

6.5 Electrical Characteristics $V_{CC+} = 2.2\text{ V}$

 $V_{CC+} = 2.2\text{ V}$, $V_{CC-} = \text{GND}$, $V_{ICR} = V_{CC+}/2$, $V_O = V_{CC+}/2$, and $R_L > 1\text{ M}\Omega$ (unless otherwise noted)

| PARAMETER | | TEST CONDITIONS | | MIN | TYP | MAX | UNIT | | |
|------------|------------------------------------|--------------------------------------------------------------------------------------|--------------------------------------------------|--------------------------------------------------|--------------------------------------------------|-------|------------------------------|-------|--|
| V_{IO} | Input offset voltage | $T_J = 25^\circ\text{C}$ | | 0.02 | 3 | | mV | | |
| | | $T_J = -40^\circ\text{C to } +125^\circ\text{C}$ | | | | 3.5 | | | |
| TCV_{IO} | Input offset voltage average drift | $T_J = 25^\circ\text{C}$ | | | 0.6 | | $\mu\text{V}/^\circ\text{C}$ | | |
| I_{IB} | Input bias current | $T_J = 25^\circ\text{C}$ | | | 260 | | nA | | |
| I_{IO} | Input offset current | $T_J = 25^\circ\text{C}$ | | | 25 | | nA | | |
| CMMR | Common-mode rejection ratio | $V_{ICR} = 0\text{ V to } 1.3\text{ V}$ | $T_J = 25^\circ\text{C}$ | 70 | 88 | | dB | | |
| | | | $T_J = -40^\circ\text{C to } +125^\circ\text{C}$ | 64 | | | | | |
| PSRR | Power-supply rejection ratio | $V_{CC+} = 2.2\text{ V to } 5\text{ V}$ $V_O = 0$, $V_{ICR} = 0$ | $T_J = 25^\circ\text{C}$ | 80 | 90 | | dB | | |
| | | | $T_J = -40^\circ\text{C to } +125^\circ\text{C}$ | 70 | | | | | |
| V_{ICR} | Input common-mode voltage | CMRR $\geq 50\text{ dB}$ | $T_J = 25^\circ\text{C}$ | | -0.3 | | V | | |
| | | | $T_J = 25^\circ\text{C}$ | | 1.3 | | | | |
| A_{VD} | Large-signal voltage gain | $R_L = 600\ \Omega$, $V_O = 0.75\text{ V to } 2\text{ V}$ | $T_J = 25^\circ\text{C}$ | 75 | 81 | | dB | | |
| | | | $T_J = -40^\circ\text{C to } +125^\circ\text{C}$ | 70 | | | | | |
| | | $R_L = 2\text{ k}\Omega$, $V_O = 0.5\text{ V to } 2.1\text{ V}$ | $T_J = 25^\circ\text{C}$ | 75 | 84 | | | | |
| | | | $T_J = -40^\circ\text{C to } +125^\circ\text{C}$ | 70 | | | | | |
| V_O | Output swing | $R_L = 600\ \Omega\text{ to } V_{CC+}/2$ | $T_J = 25^\circ\text{C}$ | 2.090 | 2.125 | | V | | |
| | | | $T_J = -40^\circ\text{C to } +125^\circ\text{C}$ | 2.065 | | | | | |
| | | | | $T_J = 25^\circ\text{C}$ | 0.071 | 0.120 | | | |
| | | | | $T_J = -40^\circ\text{C to } +125^\circ\text{C}$ | | 0.145 | | | |
| | | $R_L = 2\text{ k}\Omega\text{ to } V_{CC+}/2$ | $T_J = 25^\circ\text{C}$ | 2.150 | 2.177 | | | | |
| | | | $T_J = -40^\circ\text{C to } +125^\circ\text{C}$ | 2.125 | | | | | |
| | | | | | $T_J = 25^\circ\text{C}$ | 0.056 | | 0.080 | |
| | | | | | $T_J = -40^\circ\text{C to } +125^\circ\text{C}$ | | | 0.105 | |
| I_O | Output current | Sourcing, $V_O = 0\text{ V}$ $V_{IN(\text{diff})} = \pm 0.5\text{ V}$ | $T_J = 25^\circ\text{C}$ | 10 | 14.9 | | mA | | |
| | | | $T_J = -40^\circ\text{C to } +125^\circ\text{C}$ | 5 | | | | | |
| | | Sinking, $V_O = 2.2\text{ V}$ $V_{IN(\text{diff})} = \pm 0.5\text{ V}$ | $T_J = 25^\circ\text{C}$ | 10 | 17.6 | | | | |
| | | | $T_J = -40^\circ\text{C to } +125^\circ\text{C}$ | 5 | | | | | |
| I_{CC} | Supply current | $T_J = 25^\circ\text{C}$ | | 1.81 | 2.4 | mA | | | |
| | | $T_J = -40^\circ\text{C to } +125^\circ\text{C}$ | | | 2.6 | | | | |
| SR | Slew rate ⁽¹⁾ | $T_J = 25^\circ\text{C}$ | | | 4.9 | | V/ μs | | |
| GBW | Gain bandwidth product | $T_J = 25^\circ\text{C}$ | | | 10 | | MHz | | |
| Φ_m | Phase margin | $T_J = 25^\circ\text{C}$ | | | 67.4 | | $^\circ$ | | |
| G_m | Gain margin | $T_J = 25^\circ\text{C}$ | | | -9.8 | | dB | | |
| V_n | Input-referred voltage noise | $f = 1\text{ kHz}$ | $T_J = 25^\circ\text{C}$ | | 11 | | $\text{nV}/\sqrt{\text{Hz}}$ | | |
| I_n | Input-referred current noise | $f = 1\text{ kHz}$ | $T_J = 25^\circ\text{C}$ | | 0.3 | | $\text{pA}/\sqrt{\text{Hz}}$ | | |
| THD | Total harmonic distortion | $f = 1\text{ kHz}$, $A_V = 1$, $R_L = 600\ \Omega$, $V_O = 500\text{ mV}_{pp}$ | $T_J = 25^\circ\text{C}$ | | 0.004% | | | | |

(1) Connected as voltage follower with 1-V step input. Number specified is the slower of the positive and negative slew rate.

6.6 Electrical Characteristics $V_{CC+} = 5\text{ V}$

 $V_{CC+} = 5\text{ V}$, $V_{CC-} = \text{GND}$, $V_{ICR} = V_{CC+}/2$, $V_O = V_{CC+}/2$, and $R_L > 1\text{ M}\Omega$ (unless otherwise noted)

| PARAMETER | | TEST CONDITIONS | | MIN | TYP | MAX | UNIT |
|------------|------------------------------------|-------------------------------------------------------------------------------------|---------------------------------------------------|--------|-------|------------------------------|------------------------------|
| V_{IO} | Input offset voltage | | $T_J = 25^\circ\text{C}$ | -0.08 | | 3 | mV |
| | | | $T_J = -40^\circ\text{C}$ to $+125^\circ\text{C}$ | | | 3.5 | |
| TCV_{IO} | Input offset voltage average drift | | $T_J = 25^\circ\text{C}$ | | 0.6 | | $\mu\text{V}/^\circ\text{C}$ |
| I_{IB} | Input bias current | | $T_J = 25^\circ\text{C}$ | | 260 | | nA |
| I_{IO} | Input offset current | | $T_J = 25^\circ\text{C}$ | | 25 | | nA |
| CMMR | Common-mode rejection ratio | $V_{ICR} = 0\text{ V}$ to 4.1 V | $T_J = 25^\circ\text{C}$ | 80 | 89 | | dB |
| | | $V_{ICR} = 0\text{ V}$ to 4.1 V | $T_J = -40^\circ\text{C}$ to $+125^\circ\text{C}$ | 75 | | | |
| PSRR | Power-supply rejection ratio | $V_{CC+} = 2.2\text{ V}$ to 5 V , $V_O = 0$, $V_{ICR} = 0$ | $T_J = 25^\circ\text{C}$ | 70 | 90 | | dB |
| | | $V_{CC+} = 2.2\text{ V}$ to 5 V , $V_O = 0$, $V_{ICR} = 0$ | $T_J = -40^\circ\text{C}$ to $+125^\circ\text{C}$ | 64 | | | |
| V_{ICR} | Input common-mode voltage | CMRR $\geq 50\text{ dB}$ | $T_J = 25^\circ\text{C}$ | | -0.3 | | V |
| | | | $T_J = 25^\circ\text{C}$ | | 4.1 | | |
| A_{VD} | Large-signal voltage gain | $R_L = 600\ \Omega$, $V_O = 0.75\text{ V}$ to 4.8 V | $T_J = 25^\circ\text{C}$ | 80 | 87 | | dB |
| | | | $T_J = -40^\circ\text{C}$ to $+125^\circ\text{C}$ | 70 | | | |
| | | $R_L = 2\text{ k}\Omega$, $V_O = 0.7\text{ V}$ to 4.9 V | $T_J = 25^\circ\text{C}$ | 80 | 94 | | |
| | | | $T_J = -40^\circ\text{C}$ to $+125^\circ\text{C}$ | 70 | | | |
| V_O | Output swing | $R_L = 600\ \Omega$ to $V_{CC+}/2$ | $T_J = 25^\circ\text{C}$ | 4.84 | 4.882 | | V |
| | | | $T_J = -40^\circ\text{C}$ to $+125^\circ\text{C}$ | 4.815 | | | |
| | | | $T_J = 25^\circ\text{C}$ | | 0.134 | 0.19 | |
| | | | $T_J = -40^\circ\text{C}$ to $+125^\circ\text{C}$ | | | 0.215 | |
| | | $R_L = 2\text{ k}\Omega$ to $V_{CC+}/2$ | $T_J = 25^\circ\text{C}$ | 4.93 | 4.952 | | |
| | | | $T_J = -40^\circ\text{C}$ to $+125^\circ\text{C}$ | 4.905 | | | |
| I_O | Output current | Sourcing, $V_O = 0\text{ V}$, $V_{IN(\text{diff})} = \pm 0.5\text{ V}$ | $T_J = 25^\circ\text{C}$ | 20 | 52.6 | | mA |
| | | | $T_J = -40^\circ\text{C}$ to $+125^\circ\text{C}$ | 12 | | | |
| | | Sinking, $V_O = 2.2\text{ V}$, $V_{IN(\text{diff})} = \pm 0.5\text{ V}$ | $T_J = 25^\circ\text{C}$ | 15 | 23.7 | | |
| | | | $T_J = -40^\circ\text{C}$ to $+125^\circ\text{C}$ | 8.5 | | | |
| I_{CC} | Supply current | | $T_J = 25^\circ\text{C}$ | 2.01 | 2.4 | mA | |
| | | | $T_J = -40^\circ\text{C}$ to $+125^\circ\text{C}$ | | 2.8 | | |
| SR | Slew rate ⁽¹⁾ | | $T_J = 25^\circ\text{C}$ | 5.25 | | $\text{V}/\mu\text{s}$ | |
| GBW | Gain bandwidth product | | $T_J = 25^\circ\text{C}$ | 10 | | MHz | |
| Φ_m | Phase margin | | $T_J = 25^\circ\text{C}$ | 72 | | $^\circ$ | |
| G_m | Gain margin | | $T_J = 25^\circ\text{C}$ | -11 | | dB | |
| V_n | Input-referred voltage noise | $f = 1\text{ kHz}$ | $T_J = 25^\circ\text{C}$ | 10.5 | | $\text{nV}/\sqrt{\text{Hz}}$ | |
| I_n | Input-referred current noise | $f = 1\text{ kHz}$ | $T_J = 25^\circ\text{C}$ | 0.2 | | $\text{pA}/\sqrt{\text{Hz}}$ | |
| THD | Total harmonic distortion | $f = 1\text{ kHz}$, $AV = 1$, $R_L = 600\ \Omega$, $V_O = 500\text{ mV}_{pp}$ | $T_J = 25^\circ\text{C}$ | 0.001% | | | |

(1) Connected as voltage follower with 1-V step input. Number specified is the slower of the positive and negative slew rate.

6.7 Typical Characteristics

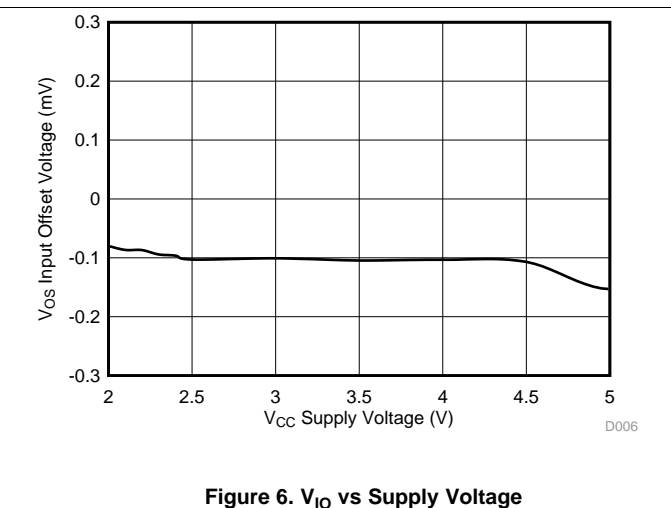
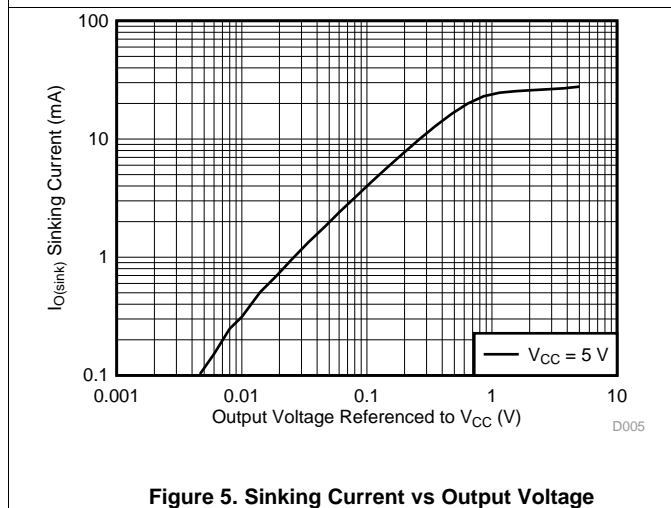
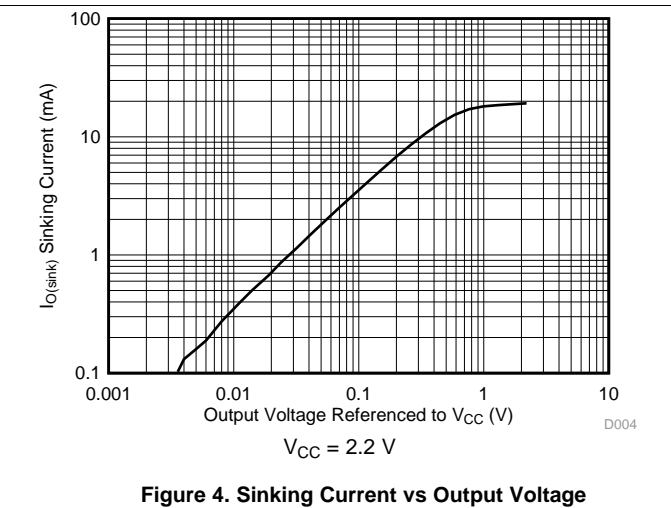
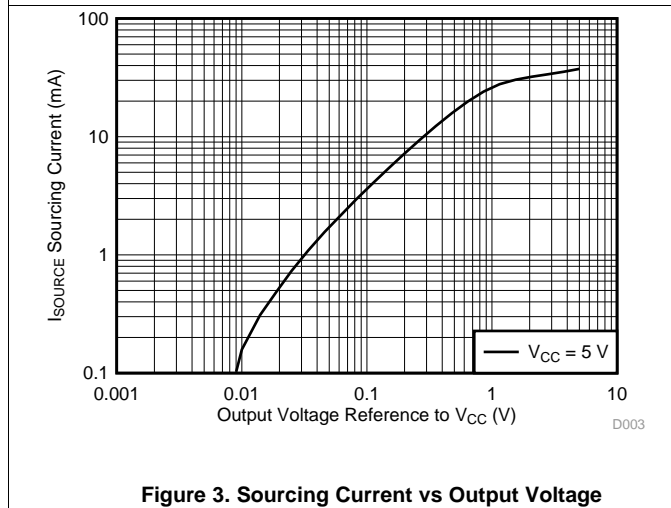
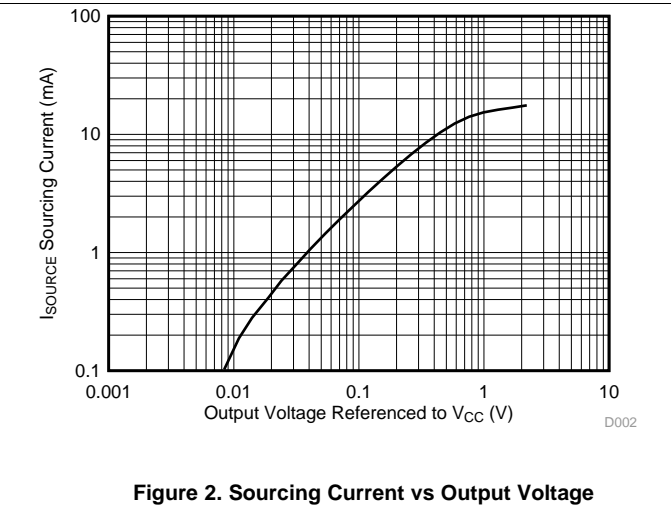
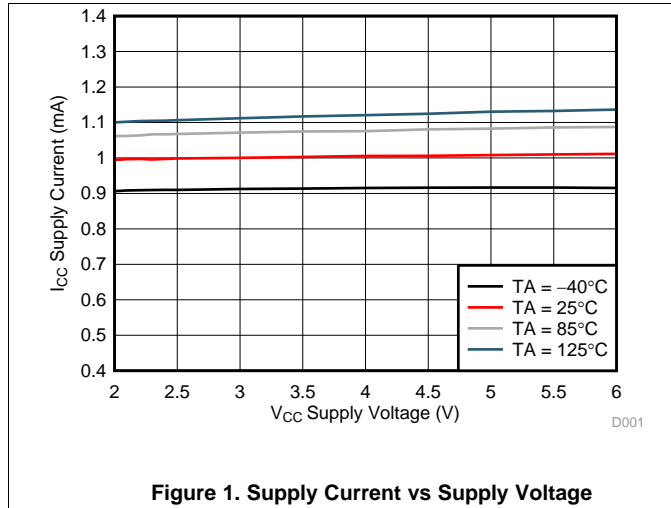

Typical Characteristics (continued)

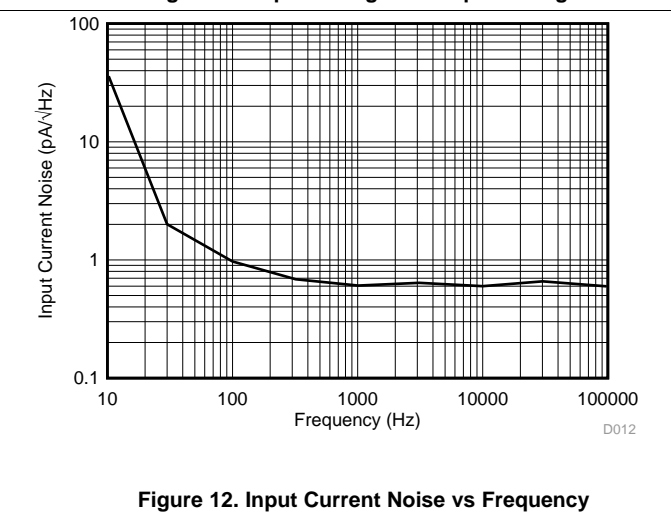
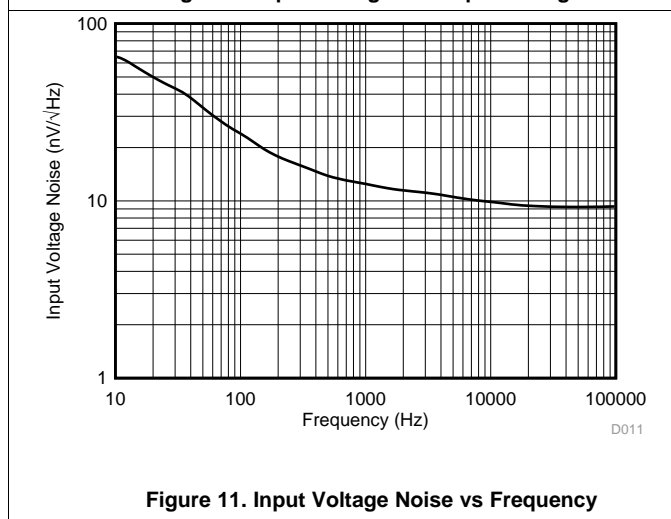
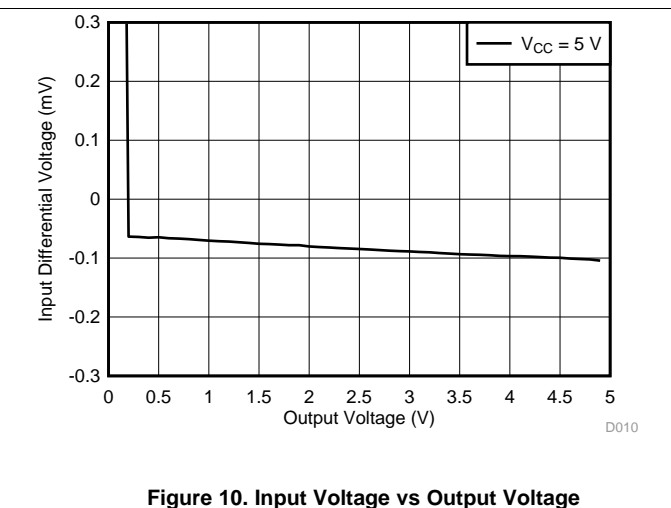
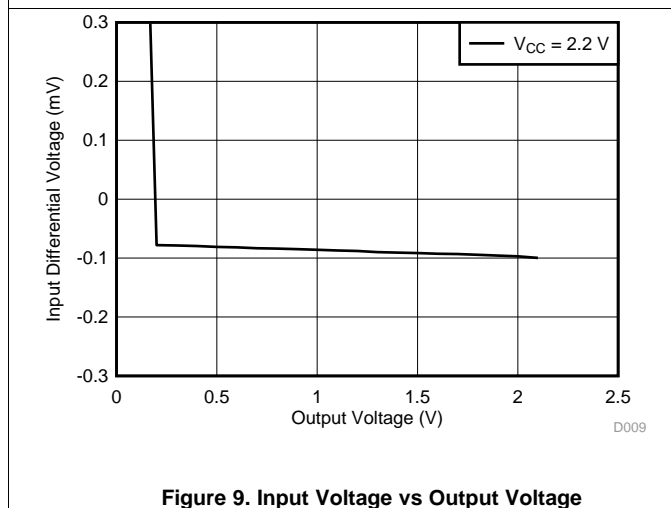
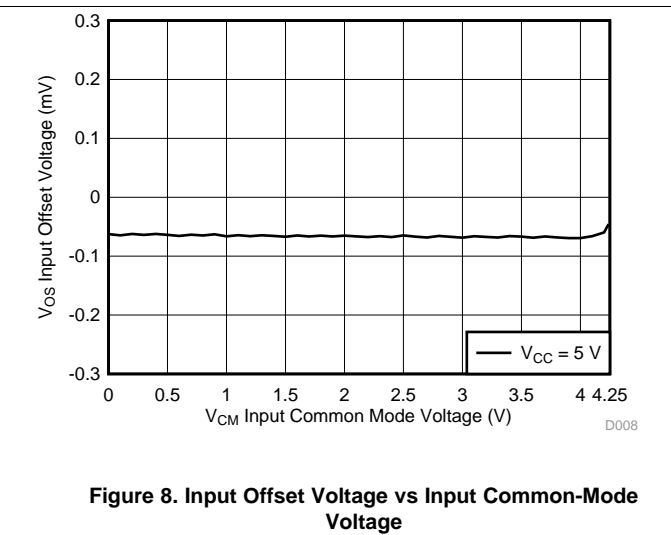
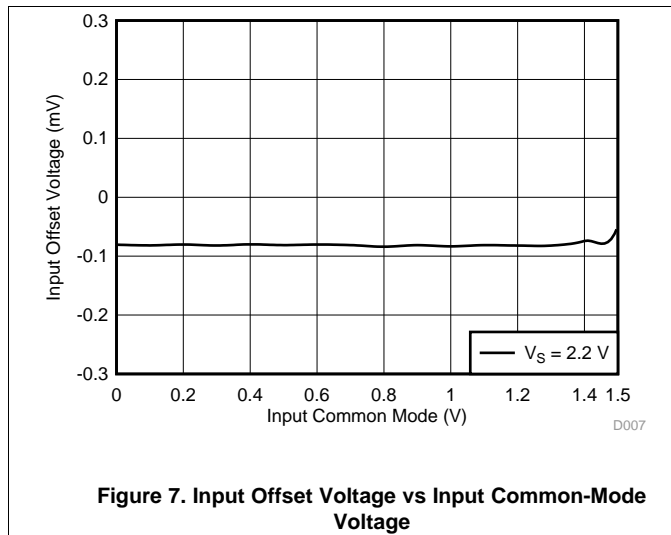

Typical Characteristics (continued)

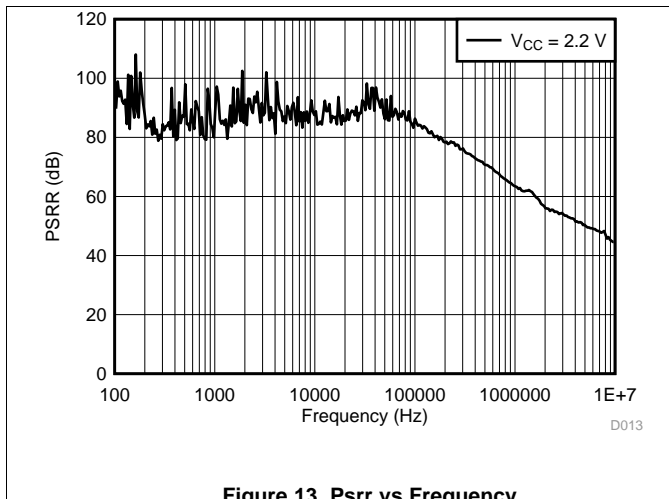

Figure 13. Psrr vs Frequency

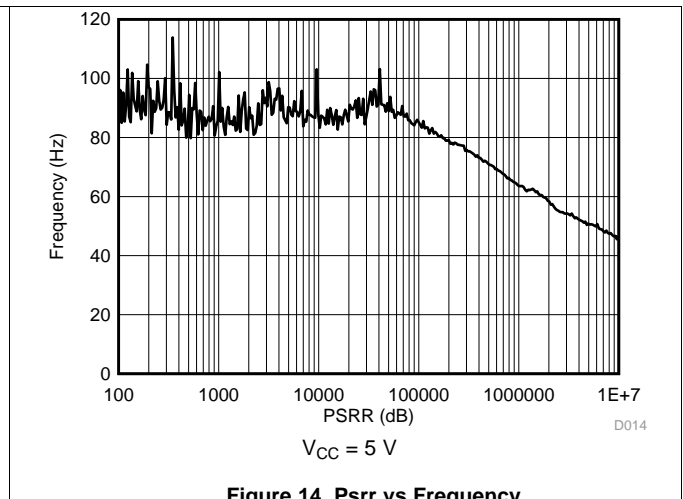

Figure 14. Psrr vs Frequency

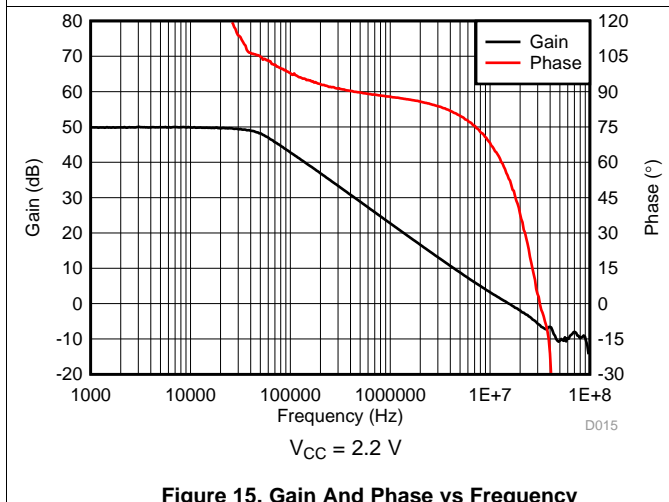

Figure 15. Gain And Phase vs Frequency

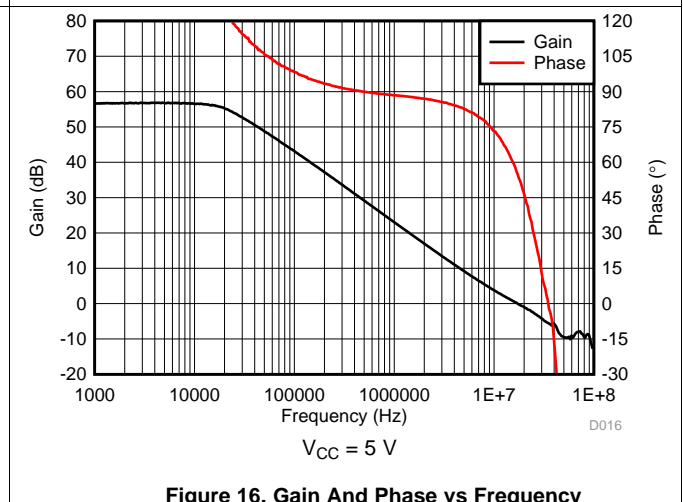

Figure 16. Gain And Phase vs Frequency

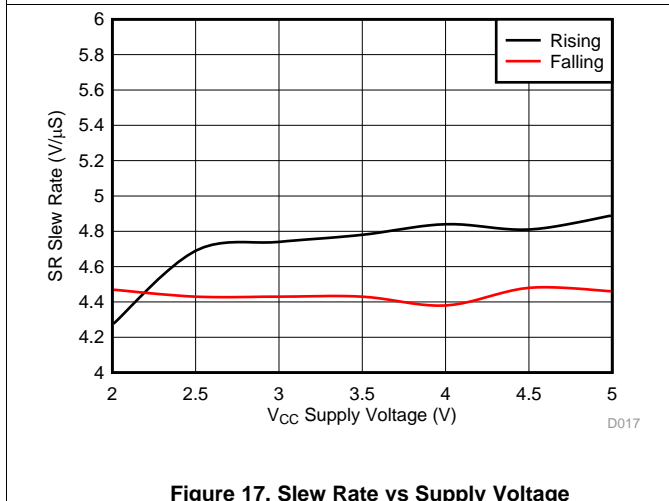

Figure 17. Slew Rate vs Supply Voltage

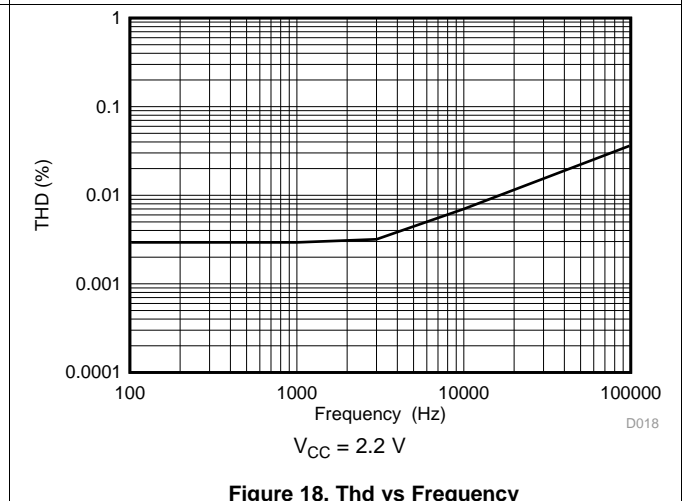
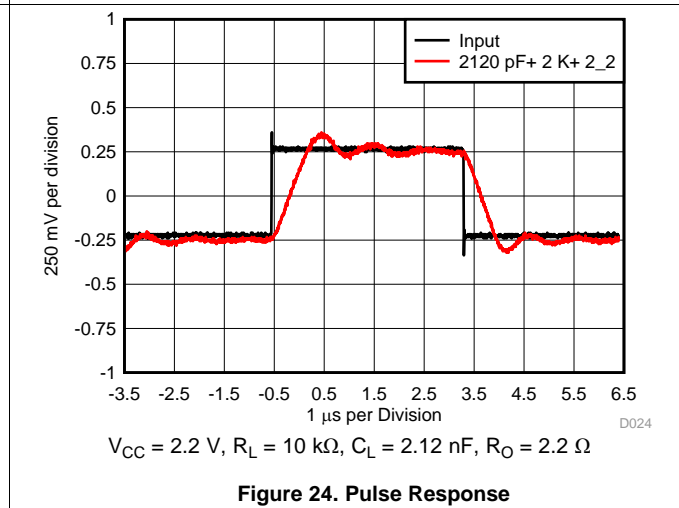
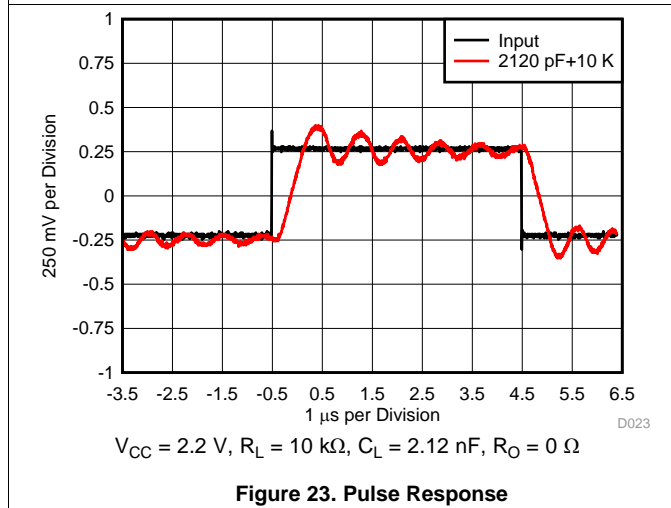
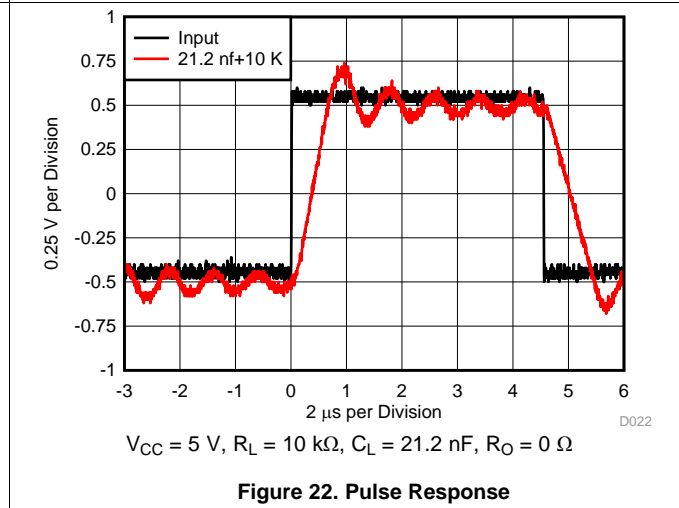
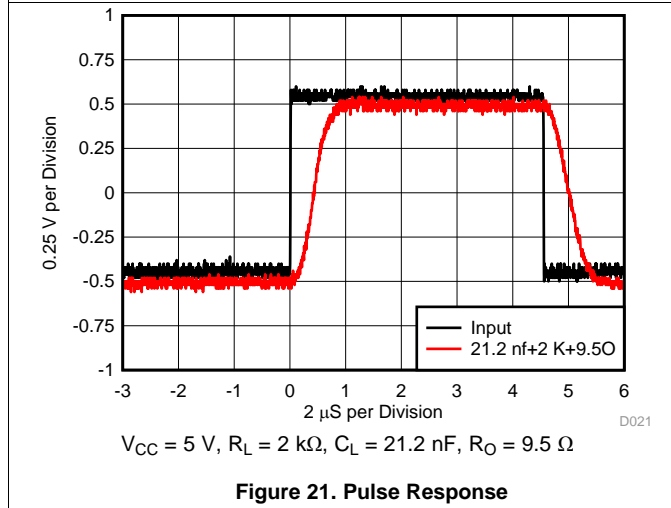
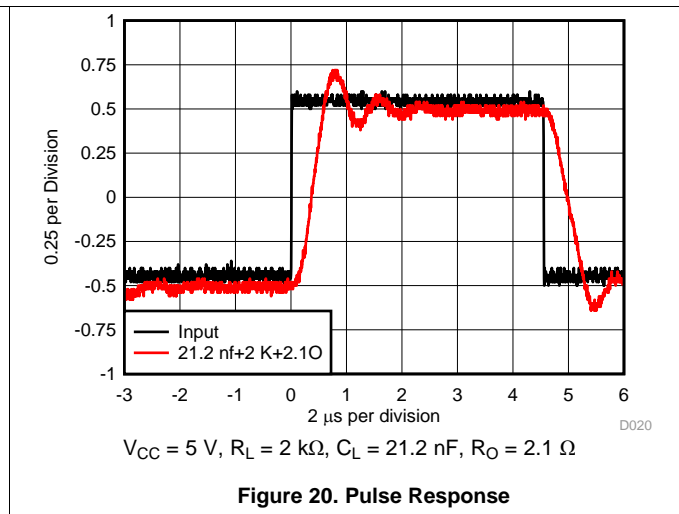
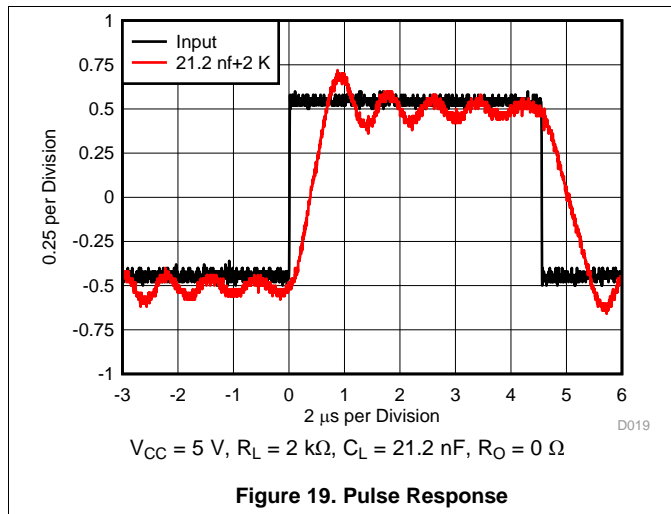
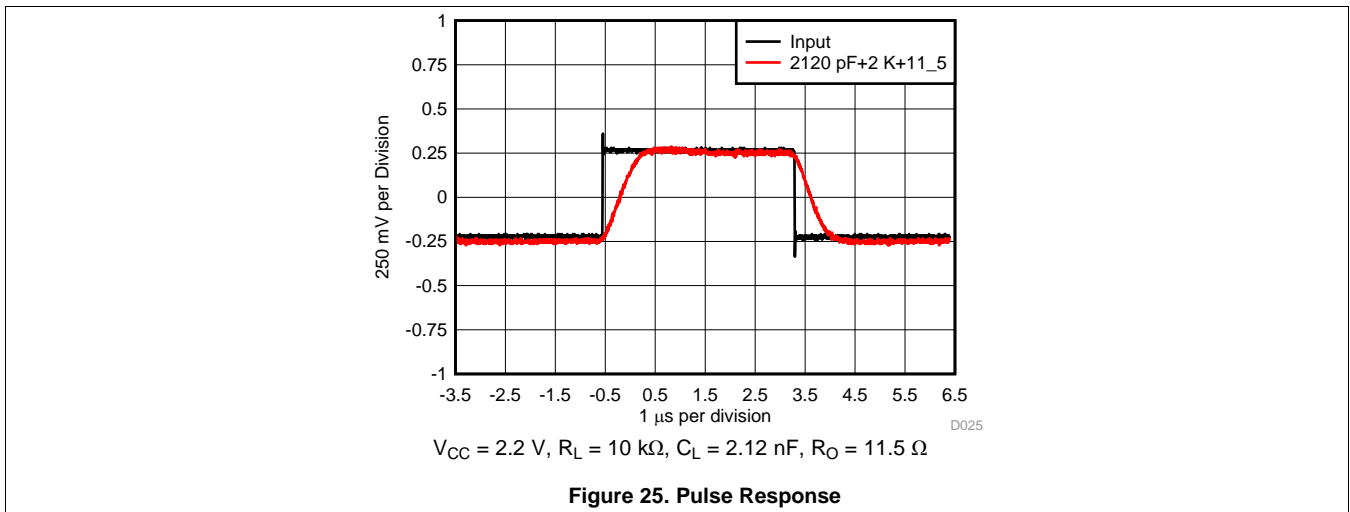

Figure 18. Thd vs Frequency

Typical Characteristics (continued)



Typical Characteristics (continued)



7 Detailed Description

7.1 Overview

The LMV722-Q1 is a low-power, low-noise, rail-to-rail output op amp. This device is AEC-Q100 qualified for automotive applications. The LMV722-Q1 operates from a single 2.2 V to 5.5 V supply, is unity-gain stable, and is suitable for a wide range of general-purpose applications. The input common-mode voltage range includes ground. Rail-to-rail input and output swing significantly increases dynamic range in low-supply applications and makes applications suitable for driving sampling analog-to-digital converters (ADCs). The small footprints of the LMV722-Q1 package saves space on printed-circuit boards and enables good signal integrity and noise performance during the design of smaller electronic products, such as automotive head units.

7.2 Functional Block Diagram

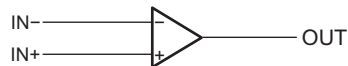

7.3 Feature Description

7.3.1 Low Noise

The LMV722-Q1 device is a general-purpose op amp that provides low noise of 10.5 nV/ $\sqrt{\text{Hz}}$ and a wide bandwidth of 10 MHz. The low noise and wide bandwidth make the LMV722-Q1 device attractive for a variety of precision applications that require a good balance between cost and performance.

7.3.2 Rail-to-Rail Output

Rail-to-rail output swing provides maximum possible dynamic range at the output. This is particularly important when operating on low-supply voltages.

7.3.3 Input Includes Ground

This feature allows direct sensing near GND in a single-supply operation.

7.3.4 Signal Integrity

Signals pick up noise between the signal source and the amplifier. By using a physically smaller amplifier package, such as the 8-pin VSSOP (DGK), the LMV722-Q1 can be placed closer to the signal source; reducing noise pickup and increasing signal integrity.

7.4 Device Functional Modes

The only mode available for the LMV722-Q1 device is *on*.

8 Application and Implementation

NOTE

Information in the following applications sections is not part of the TI component specification, and TI does not warrant its accuracy or completeness. TI's customers are responsible for determining suitability of components for their purposes. Customers should validate and test their design implementation to confirm system functionality.

8.1 Application Information

The LMV722-Q1 features 10-MHz bandwidth and 5.25-V/ μ s slew rate providing good AC performance at very-low-power consumption. DC applications are well served with a very-low input noise voltage of 10.5 nV / $\sqrt{\text{Hz}}$ at 1 kHz, low input bias current, and a typical input offset voltage of 0.02 mV.

8.2 Typical Application

Figure 26 shows the LMV722-Q1 configured in a low-side current sensing application.

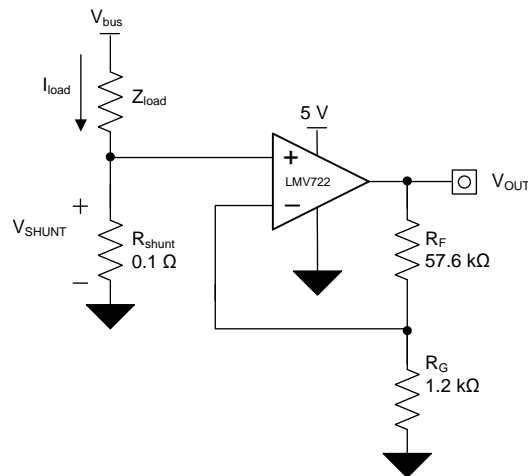

Copyright © 2017, Texas Instruments Incorporated

Figure 26. LMV722-Q1 in a Low-Side, Current-Sensing Application

8.2.1 Design Requirements

The design requirements for this design are:

- Load current: 0 A to 1 A
- Output voltage: 4.9 V
- Maximum shunt voltage: 100 mV

Typical Application (continued)

8.2.2 Detailed Design Procedure

The transfer function of the circuit in [Figure 26](#) is given in [Equation 1](#)

$$V_{OUT} = I_{LOAD} \times R_{SHUNT} \times \text{Gain} \quad (1)$$

The load current (I_{LOAD}) produces a voltage drop across the shunt resistor (R_{SHUNT}). The load current is set from 0 A to 1 A. To keep the shunt voltage below 100 mV at maximum load current, the largest shunt resistor is defined using [Equation 2](#).

$$R_{SHUNT} = \frac{V_{SHUNT_MAX}}{I_{LOAD_MAX}} = \frac{100\text{mV}}{1\text{A}} = 100\text{m}\Omega \quad (2)$$

Using [Equation 2](#), R_{SHUNT} is calculated to be 100 m Ω . The voltage drop produced by I_{LOAD} and R_{SHUNT} is amplified by the LMV722-Q1 to produce an output voltage of roughly 0 V to 4.9 V. The gain needed by the LMV722-Q1 to produce the necessary output voltage is calculated using [Equation 3](#):

$$\text{Gain} = \frac{(V_{OUT_MAX} - V_{OUT_MIN})}{(V_{IN_MAX} - V_{IN_MIN})} \quad (3)$$

Using [Equation 3](#), the required gain is calculated to be 49 V/V, which is set with resistors R_F and R_G . [Equation 4](#) is used to size the resistors, R_F and R_G , to set the gain of the LMV722-Q1 to 49 V/V.

$$\text{Gain} = 1 + \frac{(R_F)}{(R_G)} \quad (4)$$

Choosing R_F as 57.6 k Ω and R_G as 1.2 k Ω provides a combination that equals roughly 49 V/V. [Figure 27](#) shows the measured transfer function of the circuit shown in [Figure 26](#).

8.2.3 Application Curve

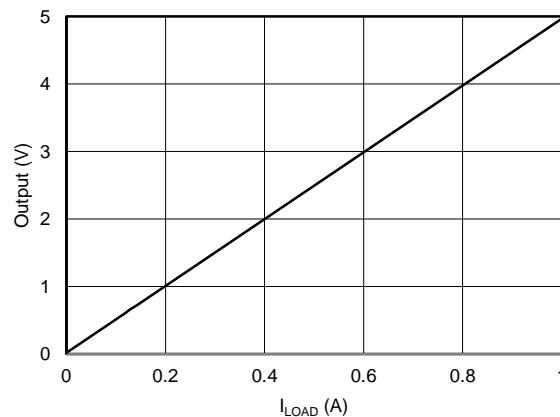

Figure 27. Low-Side, Current-Sense, Transfer Function

9 Power Supply Recommendations

The LMV722-Q1 series is specified for operation from 2.2 V to 5.5 V (± 1.1 V to ± 2.75 V); many specifications apply from -40°C to $+125^{\circ}\text{C}$. The section presents parameters that can exhibit significant variance with regard to operating voltage or temperature.

CAUTION

Supply voltages larger than 6 V can permanently damage the device; see the [Absolute Maximum Ratings](#) table.

Place 0.1- μF bypass capacitors close to the power-supply pins to reduce errors coupling in from noisy or high-impedance power supplies. For more detailed information on bypass capacitor placement, see the section.

9.1 Input and ESD Protection

The LMV722-Q1 incorporates internal ESD protection circuits on all pins. For input and output pins, this protection primarily consists of current-steering diodes connected between the input and power-supply pins. These ESD protection diodes provide in-circuit, input overdrive protection, as long as the current is limited to 10-mA, as stated in the [Layout Guidelines](#) table. [Figure 28](#) shows how a series input resistor can be added to the driven input to limit the input current. The added resistor contributes thermal noise at the amplifier input and the value must be kept to a minimum in noise-sensitive applications.

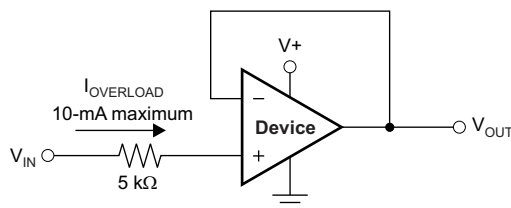

Figure 28. Input Current Protection

10 Layout

10.1 Layout Guidelines

For best operational performance of the device, use good printed circuit board (PCB) layout practices, including:

- Noise can propagate into analog circuitry through the power pins of the circuit as a whole and of op amp itself. Bypass capacitors are used to reduce the coupled noise by providing low-impedance power sources local to the analog circuitry.
 - Connect low-ESR, 0.1- μ F ceramic bypass capacitors between each supply pin and ground, placed as close to the device as possible. A single bypass capacitor from V+ to ground is applicable for single-supply applications.
- Separate grounding for analog and digital portions of circuitry is one of the simplest and most-effective methods of noise suppression. One or more layers on multilayer PCBs are usually devoted to ground planes. A ground plane helps distribute heat and reduces electromagnetic interference (EMI) noise pickup. Make sure to physically separate digital and analog grounds, paying attention to the flow of the ground current. For more detailed information refer to, see [Circuit Board Layout Techniques](#).
- In order to reduce parasitic coupling, run the input traces as far away from the supply or output traces as possible. If these traces cannot be kept separate, crossing the sensitive trace perpendicular is much better as opposed to in parallel with the noisy trace.
- Place the external components as close to the device as possible. As illustrated in [Figure 30](#), keeping RF and RG close to the inverting input minimizes parasitic capacitance on the inverting input.
- Keep the length of input traces as short as possible. Always remember that the input traces are the most sensitive part of the circuit.
- Consider a driven, low-impedance guard ring around the critical traces. A guard ring can significantly reduce leakage currents from nearby traces that are at different potentials.
- Cleaning the PCB following board assembly is recommended for best performance.
- Any precision integrated circuit can experience performance shifts resulting from moisture ingress into the plastic package. Following any aqueous PCB cleaning process, baking the PCB assembly is recommended to remove moisture introduced into the device packaging during the cleaning process. A low-temperature, post-cleaning bake at 85°C for 30 minutes is sufficient for most circumstances.

10.2 Layout Example

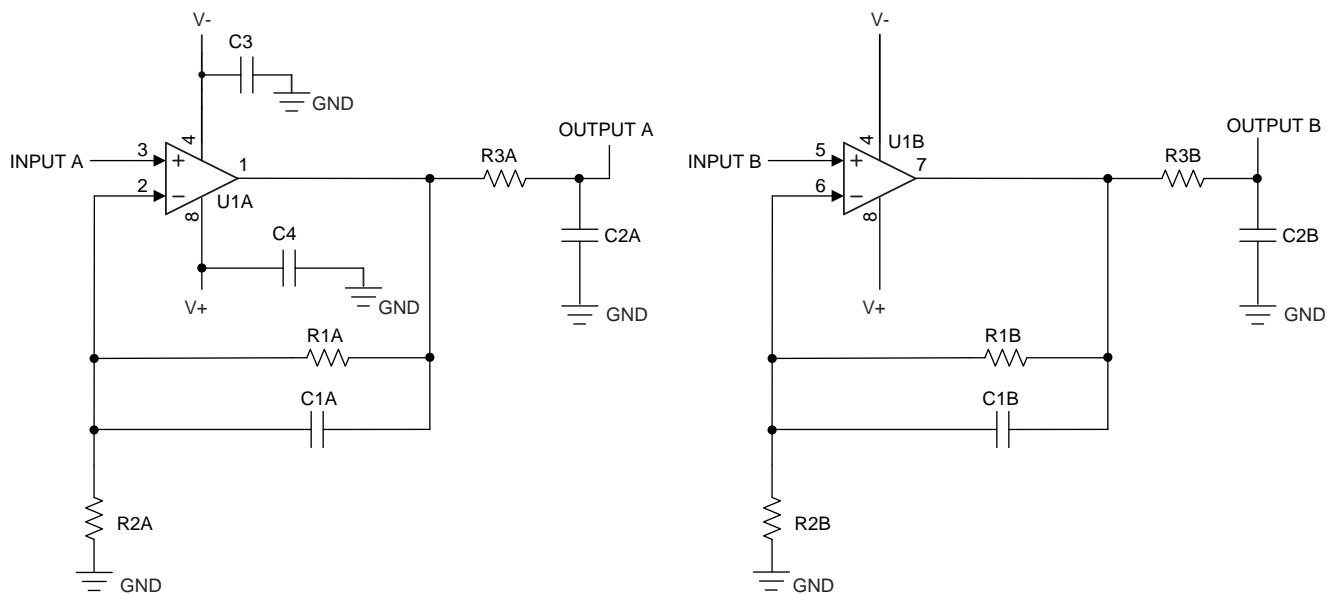

Figure 29. Schematic Representation for Figure 30

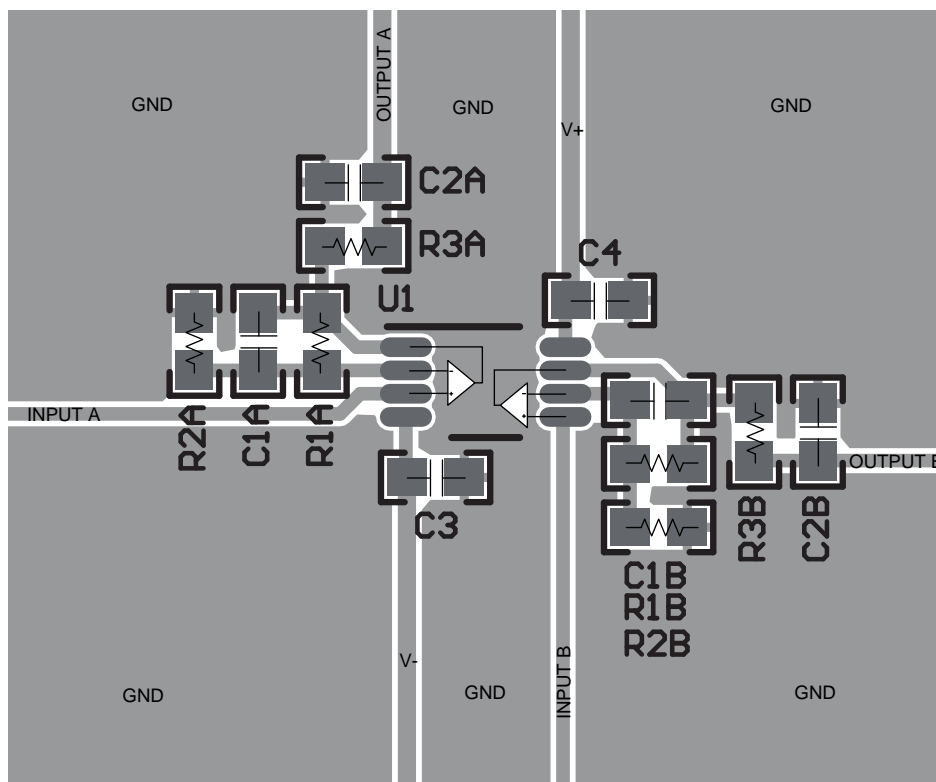

Figure 30. Layout Example

11 Device and Documentation Support

11.1 Documentation Support

11.1.1 Related Documentation

For related documentation see the following:

Texas Instruments, [Circuit Board Layout Techniques](#)

11.2 Receiving Notification of Documentation Updates

To receive notification of documentation updates, navigate to the device product folder on ti.com. In the upper right corner, click on *Alert me* to register and receive a weekly digest of any product information that has changed. For change details, review the revision history included in any revised document.

11.3 Community Resources

The following links connect to TI community resources. Linked contents are provided "AS IS" by the respective contributors. They do not constitute TI specifications and do not necessarily reflect TI's views; see TI's [Terms of Use](#).

TI E2E™ Online Community *TI's Engineer-to-Engineer (E2E) Community*. Created to foster collaboration among engineers. At e2e.ti.com, you can ask questions, share knowledge, explore ideas and help solve problems with fellow engineers.

Design Support *TI's Design Support* Quickly find helpful E2E forums along with design support tools and contact information for technical support.

11.4 Trademarks

E2E is a trademark of Texas Instruments.
All other trademarks are the property of their respective owners.

11.5 Electrostatic Discharge Caution



This integrated circuit can be damaged by ESD. Texas Instruments recommends that all integrated circuits be handled with appropriate precautions. Failure to observe proper handling and installation procedures can cause damage.

ESD damage can range from subtle performance degradation to complete device failure. Precision integrated circuits may be more susceptible to damage because very small parametric changes could cause the device not to meet its published specifications.

11.6 Glossary

[SLYZ022](#) — *TI Glossary*.

This glossary lists and explains terms, acronyms, and definitions.

12 Mechanical, Packaging, and Orderable Information

The following pages include mechanical, packaging, and orderable information. This information is the most current data available for the designated devices. This data is subject to change without notice and revision of this document. For browser-based versions of this data sheet, refer to the left-hand navigation.

PACKAGING INFORMATION

| Orderable Device | Status (1) | Package Type | Package Drawing | Pins | Package Qty | Eco Plan (2) | Lead/Ball Finish (6) | MSL Peak Temp (3) | Op Temp (°C) | Device Marking (4/5) | Samples |
|------------------|---------------|--------------|-----------------|------|-------------|-------------------------|-------------------------|----------------------|--------------|-------------------------|-------------------------|
| LMV722QDGKRQ1 | ACTIVE | VSSOP | DGK | 8 | 2500 | Green (RoHS & no Sb/Br) | NIPDAUAG | Level-2-260C-1 YEAR | -40 to 125 | R6EQ | Samples |

(1) The marketing status values are defined as follows:

ACTIVE: Product device recommended for new designs.

LIFEBUY: TI has announced that the device will be discontinued, and a lifetime-buy period is in effect.

NRND: Not recommended for new designs. Device is in production to support existing customers, but TI does not recommend using this part in a new design.

PREVIEW: Device has been announced but is not in production. Samples may or may not be available.

OBSELETE: TI has discontinued the production of the device.

(2) **RoHS:** TI defines "RoHS" to mean semiconductor products that are compliant with the current EU RoHS requirements for all 10 RoHS substances, including the requirement that RoHS substance do not exceed 0.1% by weight in homogeneous materials. Where designed to be soldered at high temperatures, "RoHS" products are suitable for use in specified lead-free processes. TI may reference these types of products as "Pb-Free".

RoHS Exempt: TI defines "RoHS Exempt" to mean products that contain lead but are compliant with EU RoHS pursuant to a specific EU RoHS exemption.

Green: TI defines "Green" to mean the content of Chlorine (Cl) and Bromine (Br) based flame retardants meet JS709B low halogen requirements of <=1000ppm threshold. Antimony trioxide based flame retardants must also meet the <=1000ppm threshold requirement.

(3) MSL, Peak Temp. - The Moisture Sensitivity Level rating according to the JEDEC industry standard classifications, and peak solder temperature.

(4) There may be additional marking, which relates to the logo, the lot trace code information, or the environmental category on the device.

(5) Multiple Device Markings will be inside parentheses. Only one Device Marking contained in parentheses and separated by a "~" will appear on a device. If a line is indented then it is a continuation of the previous line and the two combined represent the entire Device Marking for that device.

(6) Lead/Ball Finish - Orderable Devices may have multiple material finish options. Finish options are separated by a vertical ruled line. Lead/Ball Finish values may wrap to two lines if the finish value exceeds the maximum column width.

Important Information and Disclaimer:The information provided on this page represents TI's knowledge and belief as of the date that it is provided. TI bases its knowledge and belief on information provided by third parties, and makes no representation or warranty as to the accuracy of such information. Efforts are underway to better integrate information from third parties. TI has taken and continues to take reasonable steps to provide representative and accurate information but may not have conducted destructive testing or chemical analysis on incoming materials and chemicals. TI and TI suppliers consider certain information to be proprietary, and thus CAS numbers and other limited information may not be available for release.

In no event shall TI's liability arising out of such information exceed the total purchase price of the TI part(s) at issue in this document sold by TI to Customer on an annual basis.

OTHER QUALIFIED VERSIONS OF LMV722-Q1 :

- Catalog: [LMV722](#)

NOTE: Qualified Version Definitions:

- Catalog - TI's standard catalog product

TAPE AND REEL INFORMATION



QUADRANT ASSIGNMENTS FOR PIN 1 ORIENTATION IN TAPE



*All dimensions are nominal

| Device | Package Type | Package Drawing | Pins | SPQ | Reel Diameter (mm) | Reel Width W1 (mm) | A0 (mm) | B0 (mm) | K0 (mm) | P1 (mm) | W (mm) | Pin1 Quadrant |
|---------------|--------------|-----------------|------|------|--------------------|--------------------|---------|---------|---------|---------|--------|---------------|
| LMV722QDGKRQ1 | VSSOP | DGK | 8 | 2500 | 330.0 | 12.4 | 5.3 | 3.4 | 1.4 | 8.0 | 12.0 | Q1 |

TAPE AND REEL BOX DIMENSIONS



*All dimensions are nominal

| Device | Package Type | Package Drawing | Pins | SPQ | Length (mm) | Width (mm) | Height (mm) |
|---------------|--------------|-----------------|------|------|-------------|------------|-------------|
| LMV722QDGKRQ1 | VSSOP | DGK | 8 | 2500 | 366.0 | 364.0 | 50.0 |

DGK (S-PDSO-G8)

PLASTIC SMALL-OUTLINE PACKAGE



4073329/E 05/06

- NOTES:
- A. All linear dimensions are in millimeters.
 - B. This drawing is subject to change without notice.
 - C. Body length does not include mold flash, protrusions, or gate burrs. Mold flash, protrusions, or gate burrs shall not exceed 0.15 per end.
 - D. Body width does not include interlead flash. Interlead flash shall not exceed 0.50 per side.
 - E. Falls within JEDEC MO-187 variation AA, except interlead flash.



- NOTES:
- A. All linear dimensions are in millimeters.
 - B. This drawing is subject to change without notice.
 - C. Publication IPC-7351 is recommended for alternate designs.
 - D. Laser cutting apertures with trapezoidal walls and also rounding corners will offer better paste release. Customers should contact their board assembly site for stencil design recommendations. Refer to IPC-7525 for other stencil recommendations.
 - E. Customers should contact their board fabrication site for solder mask tolerances between and around signal pads.

IMPORTANT NOTICE AND DISCLAIMER

TI PROVIDES TECHNICAL AND RELIABILITY DATA (INCLUDING DATASHEETS), DESIGN RESOURCES (INCLUDING REFERENCE DESIGNS), APPLICATION OR OTHER DESIGN ADVICE, WEB TOOLS, SAFETY INFORMATION, AND OTHER RESOURCES "AS IS" AND WITH ALL FAULTS, AND DISCLAIMS ALL WARRANTIES, EXPRESS AND IMPLIED, INCLUDING WITHOUT LIMITATION ANY IMPLIED WARRANTIES OF MERCHANTABILITY, FITNESS FOR A PARTICULAR PURPOSE OR NON-INFRINGEMENT OF THIRD PARTY INTELLECTUAL PROPERTY RIGHTS.

These resources are intended for skilled developers designing with TI products. You are solely responsible for (1) selecting the appropriate TI products for your application, (2) designing, validating and testing your application, and (3) ensuring your application meets applicable standards, and any other safety, security, or other requirements. These resources are subject to change without notice. TI grants you permission to use these resources only for development of an application that uses the TI products described in the resource. Other reproduction and display of these resources is prohibited. No license is granted to any other TI intellectual property right or to any third party intellectual property right. TI disclaims responsibility for, and you will fully indemnify TI and its representatives against, any claims, damages, costs, losses, and liabilities arising out of your use of these resources.

TI's products are provided subject to TI's Terms of Sale (www.ti.com/legal/termsofsale.html) or other applicable terms available either on ti.com or provided in conjunction with such TI products. TI's provision of these resources does not expand or otherwise alter TI's applicable warranties or warranty disclaimers for TI products.

Mailing Address: Texas Instruments, Post Office Box 655303, Dallas, Texas 75265
Copyright © 2020, Texas Instruments Incorporated